

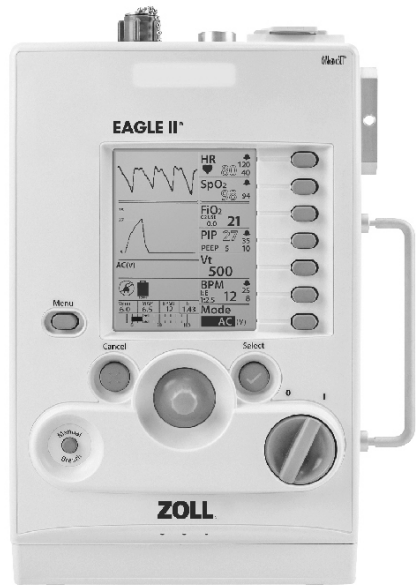

Ventilator Operator's Guide



The issue date for the *ZOLL Ventilator Operator's Guide* (REF 9650-002363-01 Rev. G) is **November, 2024**.

Copyright © 2024 ZOLL Medical Corporation. All rights reserved. AEV, Eagle II, EMV+, Smart Help, and ZOLL are trademarks and/or registered trademarks of ZOLL Medical Corporation in the United States and/or other countries. All other trademarks are the property of their respective owners.

ZOLL Patent Information

Information about ZOLL patents is available online at www.zoll.com/patents

Masimo Pulse Oximeter

This device uses Masimo SET® technology to provide continuous pulse oximeter and heart rate monitoring. Information about Masimo patents is available online at www.masimo.com/patents.htm.



Limited Copyright Release

Permission is hereby granted to any military/governmental agency to reproduce all materials furnished herein for use in a military/governmental service training program and/or other technical training program.



ZOLL Medical Corporation

269 Mill Road
Chelmsford, MA USA
01824-4105



ZOLL International Holding B.V.

Einsteinweg 8A
6662 PW Elst
Netherlands



0123

Contents

Chapter 1 General Information

| | |
|--|------|
| Product Description | 1-1 |
| How to Use this Guide | 1-1 |
| Operator's Guide Updates | 1-2 |
| Unpacking | 1-2 |
| Assembly | 1-2 |
| Product Symbols..... | 1-2 |
| Symbols on the Ventilator Graphical User Interface | 1-5 |
| Conventions | 1-7 |
| Abbreviations | 1-8 |
| Indications for Use | 1-9 |
| Ventilation | 1-9 |
| Pulse Oximetry (SpO2) | 1-9 |
| Features | 1-9 |
| Warnings..... | 1-10 |
| General | 1-10 |
| Ventilator | 1-10 |
| Pulse Oximeter | 1-11 |
| Batteries | 1-12 |
| User Safety | 1-12 |
| Patient Safety | 1-12 |
| MR Conditional Equipment | 1-13 |
| Cautions | 1-14 |
| FDA Tracking Requirements..... | 1-14 |
| Notification of Adverse Events | 1-15 |
| Software License | 1-15 |
| NO IMPLIED LICENSE | 1-15 |
| Limited Warranty | 1-15 |
| Technical Support | 1-16 |
| Returning a Ventilator for ZOLL Service | 1-17 |

Chapter 2 Product Overview

| | |
|--|------|
| Ventilator Models | 2-1 |
| Operating Mode Support | 2-2 |
| Manual Breath and Pressure Plateau Feature | 2-2 |
| Ventilator Description | 2-3 |
| Main Features | 2-3 |
| Controls and Indicators | 2-4 |
| Controls | 2-5 |
| Indicators | 2-5 |
| Display Screen | 2-5 |
| Message Area | 2-6 |
| Parameter Windows | 2-6 |
| Shared Icon Area | 2-6 |
| Auxiliary Parameter Boxes | 2-6 |
| Fresh Gas/Emergency Air Intake and Attachments | 2-7 |
| Oxygen Reservoir Kit (Optional) | 2-7 |
| Top Panel | 2-8 |
| Pulse Oximeter Compatibility | 2-9 |
| Power Sources | 2-9 |
| Operating Using External DC Power | 2-9 |
| Operating Using Battery Power | 2-10 |
| Pneumatic Design | 2-11 |
| Oxygen Input: High Pressure Gas Supply | 2-12 |
| High Pressure Oxygen Supply Hose | 2-12 |
| Patient Circuits..... | 2-14 |
| Intended Use | 2-14 |
| Use of Heat and Moisture Exchangers | 2-15 |
| Attaching a Patient Circuit to the Ventilator | 2-16 |
| Specifications | 2-17 |
| Pediatric/Adult, 6 ft Patient Circuit | 2-17 |
| Pediatric/Adult, 12 ft Patient Circuit | 2-17 |
| Infant/Pediatric, 6 ft Patient Circuit | 2-17 |
| Infant/Pediatric, 12 ftPatient Circuit | 2-18 |

Chapter 3 Setting Up the Ventilator

| | |
|---|-----|
| 1. Attach the Patient Circuit | 3-2 |
| 2. Attach the High Pressure Oxygen Supply (Optional)..... | 3-3 |
| 3. Inspect Fresh Gas/Emergency Air Intake Filter | 3-4 |
| 4. Connect Fresh Gas/Emergency Air Intake Attachments (Optional)..... | 3-4 |
| Oxygen Reservoir Kit | 3-4 |
| Bacterial/Viral (BV) Filter | 3-6 |
| Chemical/Biological C2A1 Filter | 3-6 |
| 5. Select the Ventilator's Power Source..... | 3-6 |
| Connecting the Power Supply | 3-7 |
| 6. Turn On the Ventilator..... | 3-8 |
| 7. Select Start Menu Option..... | 3-8 |
| 8. Change Operating Mode (Optional)..... | 3-9 |

9. Change Parameter Values 3-10
 10. Perform Operational Test 3-10
 11. Attach the Pulse Oximeter (Optional)..... 3-11
 12. Attach Patient..... 3-12

Chapter 4 Using the Ventilator

Operating Mode Availability 4-2
 Initial Operation with Default Parameter Settings 4-3
 Default Parameter Settings for Adult, Pediatric and Mask CPAP 4-3
 Adult Default Parameter Setting Values 4-3
 Making a Choice From the Start Menu 4-4
 Changing Parameter Settings..... 4-5
 Navigating the Parameter Windows Using Parameter Buttons 4-6
 Changing a Parameter Setting 4-7
 Example 1 — Changing a Primary Parameter 4-7
 Example 2 — Changing a Secondary Parameter 4-7
 Example 3— Changing a Context Menu Parameter 4-7
 Saving Changed Parameters for Future Use..... 4-8
 Using the Last Settings Enabled on the Ventilator..... 4-8
 Mode Parameter Window Options 4-9
 Primary Parameter 4-9
 Secondary Parameters and Alarm Thresholds/Limits 4-9
 Breath Target 4-9
 Leak Compensation 4-10
 Context Menu 4-10
 Mode Parameter Window Reference 4-11
 BPM Parameter Window Options 4-12
 Secondary Parameters and Alarm Thresholds/Limits 4-12
 Context Menu 4-12
 Control Parameter (I:E or Ti) 4-13
 Rise Time 4-13
 Cycle Off % Parameter 4-14
 Spont Ti Limit Parameter 4-14
 BPM Parameter Window Reference 4-15
 Vt Parameter Window Options 4-16
 Secondary Parameters and Alarm Thresholds/Limits 4-16
 Context Menu 4-17
 Vt Parameter Window Reference 4-18
 PIP Parameter Window Options 4-18
 Secondary Parameters and Alarm Thresholds/Limits 4-18
 Context Menu 4-19
 PIP Parameter Window Reference 4-20
 FIO2 Parameter Window Options 4-21
 Secondary Parameters and Alarm Thresholds/Limits 4-21
 Context Menu 4-21
 FIO2 Parameter Window Reference 4-22

| | |
|--|------|
| SpO2 Parameter Window Options..... | 4-22 |
| Secondary Parameters and Alarm Thresholds/Limits | 4-23 |
| Context Menu | 4-23 |
| SpO2 Parameter Window Reference | 4-24 |
| HR (Heart Rate)..... | 4-25 |
| Secondary Parameters and Alarm Thresholds/Limits | 4-25 |
| Context Menu | 4-25 |
| HR Parameter Window Reference | 4-26 |
| Manual Breath | 4-27 |
| Plateau Pressure | 4-27 |
| Plateau Pressure Maneuver | 4-27 |
| Popup Messages | 4-28 |
| Popup Message List | 4-29 |
| Transitions | 4-36 |
| Using the Menu..... | 4-37 |
| Alarm Configuration | 4-37 |
| Powerup | 4-37 |
| Specifying Powerup Settings | 4-38 |
| Specifying Custom Settings | 4-38 |
| Specifying a Language | 4-38 |
| LCD Contrast | 4-38 |
| LCD Brightness | 4-39 |
| UTC Offset | 4-39 |
| Unit Info | 4-40 |
| Alarm History | 4-40 |

Chapter 5 Alarms

| | |
|--|------|
| Alarm Overview | 5-1 |
| Muting Alarms | 5-3 |
| Alarm Priorities | 5-3 |
| High Priority | 5-3 |
| Medium Priority | 5-3 |
| Low Priority (Advisory) | 5-3 |
| Popup Messages | 5-4 |
| Alarm Types..... | 5-4 |
| Patient Safety Alarm Type | 5-4 |
| Environmental and Use Alarm Types | 5-7 |
| Complete Power Failure | 5-9 |
| Self-Check Alarm Types | 5-9 |
| Managing Alarms | 5-11 |
| Alarm Muting | 5-12 |
| Start Up Muting | 5-12 |
| Preemptive Muting | 5-12 |
| Disabling Alarms from the Alarm Configuration Menu | 5-14 |
| Patient Detect Mode | 5-14 |
| Backup Modes | 5-15 |
| Apnea Backup Mode | 5-15 |

| | |
|------------------------------|------|
| Alarm Summary | 5-16 |
| High Priority Alarms | 5-16 |
| Medium Priority Alarms | 5-22 |
| Low Priority Alarms | 5-31 |

Chapter 6 Operating Environments

| | |
|---|-----|
| When External Power is Unavailable..... | 6-1 |
| Extending Battery Runtime | 6-1 |
| Using an External Battery | 6-2 |
| Using the Ventilator in Transport Environments..... | 6-2 |
| Using the Ventilator in Harsh Environments | 6-2 |
| Airborne Particulates | 6-2 |
| Extreme Temperature Environments | 6-3 |
| Operating at High Temperatures | 6-3 |
| Operating at Low Temperatures | 6-3 |
| Altitude | 6-4 |
| Rain and Snow | 6-4 |
| Using the Ventilator in Hazardous Environments | 6-4 |
| Bacterial/Viral Filter Use | 6-5 |
| Chemical/Biological Filter Use | 6-5 |
| Check Valve on Patient Circuit when in Hazardous Environments | 6-6 |
| Using the Ventilator in an MRI Environment..... | 6-7 |

Chapter 7 Maintenance

| | |
|--|-----|
| Inspecting the Ventilator | 7-1 |
| Cleaning..... | 7-2 |
| Post-Contaminated Environment Cleaning | 7-2 |
| Fresh Gas/Emergency Air Intake Filter..... | 7-3 |
| Inspecting and Replacing the Disk Filter | 7-3 |
| Replacing Ventilator Filter..... | 7-3 |
| Replacing the Disk Filter | 7-4 |
| Battery Maintenance..... | 7-6 |
| Battery Storage..... | 7-7 |
| Battery Replacement and Shipping Regulations | 7-7 |
| Ventilator Storage | 7-8 |
| Calibration Checks..... | 7-8 |
| Pulse Oximeter Check..... | 7-8 |
| Electrical Safety Check..... | 7-8 |
| Troubleshooting | 7-9 |

Appendix A Specifications

| | |
|--|-----|
| General | A-1 |
| Pulse Oximeter | A-3 |
| Device Classification..... | A-4 |
| Emissions and Immunity Compliance..... | A-5 |

Electromagnetic ImmunityA-6
Basic Safety and Essential Performance.....A-7

Appendix B Accessories

Appendix C Pulse Oximeter Principles

Pulse Oximeter SignalingC-1
 Successful Monitoring for SpO₂, PR and PiC-2
 Functional Oxygen Saturation (SpO₂)C-2
Pulse Oximeter OperationC-2
Understanding Alarm Response DelayC-3

Appendix D Troubleshooting Patient Circuits

Troubleshooting Procedure.....D-1

Appendix E Transitions

Transition OverviewE-1
 Mode Transition and Leak Compensation SelectionE-2
 BPM Parameter Window GroupE-2
 Vt Parameter Window GroupE-2
 PIP Parameter Window GroupE-2
AC and SIMV Transitions.....E-3
 AC and SIMV Mode TransitionsE-3
 AC and SIMV Leak Compensation SelectionE-3
CPAP and BL Transitions.....E-4
 CPAP and BL Mode TransitionE-4
 CPAP and BL Leak Compensation SelectionE-4
Spontaneous Breath Mode Transitions.....E-5
 AC or SIMV to CPAP Transitions with Spontaneous BreathE-6
 AC or SIMV to BL Transitions with Spontaneous BreathE-6
 CPAP or BL to (P) Transitions with Spontaneous BreathE-7
 CPAP or BL to SIMV (P) Transitions with Spontaneous BreathE-7

Index

Chapter 1

General Information

This chapter provides general information about the ZOLL[®] ventilators and the ZOLL Ventilator Operator's Guide, which we provide with this product. Specifically, this chapter provides:

- A brief description of the ventilator.
- Information about this manual (*ZOLL Ventilator Operator's Guide*).
- A table that describes the symbols that appear on a ventilator and in this manual.
- Ventilator **Indications for Use**.
- A list of **Warnings** and **Cautions** regarding the use of ZOLL ventilators.
- Information regarding FDA tracking requirements, and the product's warranty and software license.
- How to contact ZOLL Medical Corporation for service to this product.

Product Description

ZOLL ventilators are small, extremely durable, full-featured portable mechanical ventilator designed to operate in hospitals or severe and under-resourced environments. They can be used in prehospital, aeromedical, field hospital and hospital settings.

How to Use this Guide

The ZOLL Ventilator Operator's Guide provides information that users need for the safe and effective use and care of ZOLL ventilators. It is important that all persons using this device read and understand all the information contained within.

Please thoroughly read the warnings section.

Procedures for device care are located in Chapter 7, "Maintenance."

Operator's Guide Updates

An issue or revision date for this manual is shown on the front cover.

All users should carefully review each manual update to understand its significance and then file it in its appropriate section within this manual for subsequent reference.

Product documentation is available through the ZOLL website at www.zoll.com.

Unpacking





Carefully inspect each container for damage. If the shipping container or cushion material is damaged, keep it until the contents have been checked for completeness and the device has been checked for mechanical and electrical integrity. If the contents are incomplete, if there is mechanical damage, or if the ventilator does not pass its Self-Check test when turned on, U.S.A. customers should call ZOLL Medical Corporation (1-978-421-9655). Customers outside of the U.S.A. should contact the nearest ZOLL authorized representative. If the shipping container is damaged, also notify the carrier. If there is no apparent sign of mechanical damage, read instructions contained within this manual before attempting operation.













Assembly











The device only requires that you attach the breathing circuit to begin ventilation using either battery or external power. Both the ventilator and breathing circuit are supplied clean and are ready for use on a patient.

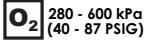

Product Symbols

The following symbols appear on a ventilator or in this manual:

| Symbol | Description |
|---|--|
|  | Off |
|  | On |
|  | Direct Current: Identifies the location to connect external DC Power. |
|  | Mute / Cancel: Identifies button which mutes the active alarms or cancels the parameter selection. |
|  | Accept /Select: Identifies button which accepts the parameter selection. |







| Symbol | Description |
|---|---|
|  | ESD: Warns that connector pins should not be touched. |
|  | Identifies the dial that allows the selection of parameter values. |
|  | Do Not Re-Use: This item should not be re-used. |
|  | Do Not Discard: Follow all governing regulations regarding the disposal of any part of this medical device. |
|  | Serial Number: Numbers following "SN" indicate the serial number. |
|  | Defibrillation Proof: Indicates the degree of protection against electrical shock. |
|  | BF Symbol: Protection against electric shock, Type B with floating (F-type) parts. |
|  | MR Symbol: Identifies the use of the device's ability to perform in a MRI environment. |
|  | Power Input Orientation: Locates the DC input identifying its point of insertion. |
|  | Manufacturer: This symbol identifies the name and address of the manufacturer. |
|  | Manufacturer Date: Manufacturer Date Symbol identifies the device's date of manufacture. |
|  | Consult Instruction: Consult the instructions for use or operation manual. |











| Symbol | Description |
|---|--|
|  | Refer to instruction manual. |
|  | Menu icon. This icon identifies the button that, when pressed, displays a menu of options that you can select to configure the ventilator. |
|  | High Pressure O ₂ Connector (top faceplate icon). Maximum Operational Flow Rate: 100 l/m (liters per minute). |
|  | Exhalation Valve (top faceplate icon). |
|  | Exhaust Do Not Occlude (top faceplate icon). |
|  | Transducer (top faceplate icon). |
|  | Gas Output -- Patient Circuit Connector (top faceplate icon). |
|  | Contains Phthalates |
|  | Non-Sterile |
|  | Conformité Européenne Complies with medical device directive 93/42/EEC. |
|  | Indicates a carrier that contains Unique Device Identifier information. |

| Symbol | Description |
|---|--|
|  | Indicates the item is a medical device. |
|  | Indicates the entity importing the medical device into the locale. |

Symbols on the Ventilator Graphical User Interface

The following symbols appear on the ventilator's Graphical User Interface (GUI):

| Symbol | Description |
|---|---|
|  | Heart: Provides indication that the pulse oximeter is in use. |
|  | Alarm Bell Outline: Identifies alarm limit settings; Identifies the on-screen alarms. |
|  | Alarm Bell: Identifies the number of off-screen alarms. |
|  | O ₂ reservoir mode is in use. |
|  | Leak Compensation (LC) feature is ON. |
|  | Leak Compensation Feature is OFF. |
|  | Patient Detect Mode: Backup Ventilation Started. |

| Symbol | Description |
|---|--|
| -- | Not receiving a reading from the pulse oximeter. |
|  | Warning: High Priority Alarm Active. |
|  | Caution: Medium Priority Alarm Active. |
|  | Attention: Low Priority Alarm Active. |
|  | Mute: Active Alarm Audible Signal Muted. |
|  | Speaker: Active Alarm Audible Signal. |
|  | Oxygen Supply: Oxygen Supply Connected. |
|  | External Power: Indicates the device is operating using an external power source. |
|  | No External Power: Indicates the device is operating without an external power source. |
|  | Internal Battery: Provides indication of battery capacity and charging. |
| EXT BATT | Indicates that an external battery is powering the ventilator. |
|  | No Internal Battery: Indicates when internal battery is not an available power source. |

| Symbol | Description |
|---|--|
|  | Head with Mask: the device is in the non-invasive positive pressure ventilation modes, CPAP or BL, with Leak Compensation turned on. |
| off | Feature OFF -- feature or alarm not selected. |
| on | Feature ON -- feature or alarm has been selected. |
| srch | Search (Pulse oximeter searching for a patient signal.) |
| stby | Standby (Pulse oximeter in standby.). |

Conventions

This guide uses the following conventions:

- Within text, the names and labels for physical buttons and soft-keys appear in boldface type (for example, “Press the **Accept** button”).
- Within text, system and alarm messages which display on the screen appear with initial capitalization.(for example, External Power Failure).

Warning! **Warning statements alert you to conditions or actions that can result in personal injury or death.**

Caution Caution statements alert you to conditions or actions that can result in damage to the device.

Abbreviations

| | |
|---|---|
| A/C - Assist/Control | ID - Internal Diameter |
| AEV - Automatic Electrical Ventilator | IPAP - Inspiratory Positive Airway Pressure. |
| ACLS - Advanced Cardiac Life Support | L - Liters |
| ALS - Advanced Life Support | LC - Leak Compensation |
| ATLS - Advanced Trauma Life Support | LCD - Liquid Crystal Display |
| ACV - Assist-Control Ventilation | LED - Light Emitting Diode |
| AMC - Alarm Message Center | LPM - Liters Per Minute (flow) |
| APOD - Advanced Probe Off Detection | l/min - liters per minute (minute volume) |
| ATPD - Ambient Temperature and Pressure Dry | ml - Milliliters |
| b/min - Beats Per Minute | mm - Millimeter |
| B/V - Bacterial/Viral Filter | MRI - Magnetic Resonance Imaging |
| BL - Bilevel positive airway pressure | O₂ - Oxygen |
| BPM - Breaths per Minute | P_{aw} - Airway Pressure |
| cm H₂O - Centimeters of Water | PEEP - Positive End Expiratory Pressure |
| CPAP - Continuous Positive Airway Pressure | PIP - Peak Inspiratory Pressure |
| CPR - Cardiopulmonary Resuscitation | PPV - Positive-Pressure Ventilation |
| CPU - Central Processor Unit | PS - Pressure Support |
| C_T - Tubing Compliance | psig - Pounds per Square Inch Gage |
| dBA - Decibel | RF - Radio Frequency |
| DISS - Diameter Index Safety System | RGA # - Returned-Goods-Authorization number |
| EMC - Electromagnetic Compatibility | RTC - Real Time Clock |
| EMV - Emergency Medical Ventilator | SIMV - Synchronized Intermittent Mandatory Ventilation |
| EPAP - Expiratory Positive Airway Pressure | SPM - Smart Pneumatic Module |
| ESD - Electrostatic Discharge | SpO₂ - Oxyhemoglobin Saturation, % |
| FIO₂ - Fraction of Inspired Oxygen | USP - United States Pharmacopoeia |
| HME - Heat and Moisture Exchanger | VAC - Volts AC |
| HMEF - Heat and Moisture Exchanger/Bacterial Viral filter combined | VDC - Volts DC |
| hPa - Hectopascal | V_T - Tidal Volume |
| HP O₂ - High Pressure Oxygen | WOB - Work Of Breathing |
| Hz - Hertz (as in frequency, cycles per second) | |
| I:E - Inspiratory/Expiratory Ratio | |

Indications for Use

Ventilation

The ZOLL ventilator is indicated for use in the management of infant through adult patients weighing ≥ 5 kg with acute or chronic respiratory failure or during resuscitation by providing continuous positive-pressure ventilation. ZOLL ventilators are appropriate for use in hospitals, outside the hospital, during transport and in severe environments where they may be exposed to rain, dust, rough handling, and extremes in temperature and humidity. With an appropriate third-party filter in place, they may be operated in environments where chemical and/or biological toxins are present. When marked with an “MRI conditional” label, the ZOLL ventilators are suitable for use in an MRI environment with appropriate precautions. ZOLL ventilators are intended for use by skilled care providers with knowledge of mechanical ventilation, emergency medical services (EMS) personnel with a basic knowledge of mechanical ventilation, and by first responders under the direction of skilled medical care providers.

Pulse Oximetry (SpO₂)

The ventilator pulse oximeter with Masimo SET technology is intended for use for continuous noninvasive monitoring of the oxygen saturation of arterial hemoglobin (SpO₂), and pulse rate. The pulse SpO₂ oximeter and accessories are indicated for use with adult and pediatric patients during both no motion and motion conditions, and for patients who are well or poorly perfused, in hospitals, hospital-type facilities, or in mobile environments.

Features

- Portable ventilator that you can use in the hospital, aeromedical and ground transport, mass casualty situations, and extreme environments.
- Multiple modes of ventilation for use with acute or chronic respiratory failure in both intubated and non-intubated patients.
- Intuitive user interface minimizes user training and protects existing settings from inadvertent contact and manipulation.
- Smart Help™ messages guide the user through on-screen commands when responding to alarms.
- Lightweight < 4.4 kg — for easy transport.
- Rechargeable battery provides over 10 hours of operation (at factory default with pulse oximeter operating).
- Operating temperature range for extreme conditions: -15 to 131°F.
- Altitude compensation from 110 to 37.6 kPa (-2,250 to 25,000 ft).
- Self-contained system able to operate with or without external oxygen.
- Gas manifold design allows operation with both high and low-pressure oxygen sources. All oxygen is delivered to the patient breathing circuit.
- Sealed gas path with chemical/biological filter connected to assure safe breathing gas supply.
- Case and control panel protects components from weather and fluids.

Warnings

General

- ZOLL ventilators are intended for use by qualified personnel only. You should read this manual before using the device.
- Before using a ZOLL ventilator on a patient, you must test the device in its normal configuration to ensure proper operation.
- Do not modify this equipment without authorization of the manufacturer.
- This operator's guide is not meant to supersede any controlling operating procedure regarding the safe use of assisted ventilation.
- Follow all governing regulations regarding the disposal of any part of this medical device, the handling of materials contaminated by body fluids, and shipment of the Li-ION batteries.

Ventilator

- ZOLL ventilators can operate from its internal battery or from an external power source. When using external power, position the power cord to avoid accidental disconnect.
- The use of accessories and cables other than those sold by ZOLL may result in increased emissions or decreased immunity of this device.
- Portable and mobile RF communication equipment may affect the performance of this device. We describe the EMC performance for this device in Appendix A Specifications of this guide.
- ZOLL ventilators may cause radio interference or may disrupt the operation of nearby equipment. It may be necessary to take mitigation measures, such as re-orienting or relocating of the device or shielding the location.
- Do not connect to an electrical outlet controlled by a wall switch or dimmer.
- The protection against defibrillator depends on the use of accessories (including Pulse Oximeter) that are specified by ZOLL.
- Grounding:
 - **Class I Power Supplies:** Do not under any circumstances remove the grounding conductor from the power plug.
 - Do not use extension cords or adapters of any type. The power cord and plug must be intact and undamaged.
 - If there is any doubt about the integrity of the protective earth conductor or power supply, operate the ventilator on internal battery power.
 - Class I supplies used in the EMS environment must be fixed to the ambulance by qualified service personnel.
 - When installing the holder and Class I power supply, check the integrity of the protective earthing system of the ambulance and ensure that the power supply is properly connected to this external protective earthing system.
- As with all medical equipment, carefully route the patient circuit, patient cabling, and external power cords to reduce the possibility of patient entanglement or strangulation.



The product design includes materials with phthalates in the pressure lines of both the manifold design and patient circuit. Patient mask accessories used with the device also are made with materials containing phthalates. Phthalates are NOT present in the inspiratory line (blue hose/tube) of the patient circuit.

- Do not use in MRI environment unless MRI marking is present.
- Do not operate the ventilator on a patient when the USB port is connected to any other device (the USB port is **only** for servicing the ventilator).
- The ZOLL-supplied patient circuit's labeling provides the resistance and compliance values for the circuits under normal operating conditions. If added accessories are used (e.g. HME, filters etc.), you should assure they do not degrade the performance of the device.

Pulse Oximeter

- Do not use the pulse oximeter as an apnea monitor.
- A pulse oximeter should be considered an early warning device. As a trend towards patient deoxygenation is indicated, blood samples should be analyzed by a laboratory co-oximeter to completely understand the patient's condition.
- Measurements: if the accuracy of any measurement does not seem reasonable, first check the patient's vital signs by alternate means and then check the pulse oximeter for proper functioning.
Inaccurate measurements may be caused by:
 - Incorrect sensor application or use.
 - Significant levels of dysfunctional hemoglobin (e.g. carboxyhemoglobin or methemoglobin).
 - Intra-vascular dyes such as indocyanine green or methylene blue.
 - Exposure to excessive illumination, such as surgical lamps (especially ones with a xenon light source), bilirubin lamps, fluorescent lights, infrared heating lamps, or direct sunlight (exposure to excessive illumination can be corrected by covering the sensor with a dark or opaque material).
 - Excessive patient movement.
 - Venous pulsations.
 - Placement of a sensor on an extremity with a blood pressure cuff, arterial catheter, or intravascular line.
 - The pulse oximeter is defibrillator-proof. The pulse oximeter can be used during defibrillation, but the readings may be inaccurate for a short time.
- Interfering Substances: carboxyhemoglobin may erroneously increase readings. The level of increase is approximately equal to the amount of carboxyhemoglobin present. Dyes, or any substance containing dyes, that change usual arterial pigmentation may cause erroneous readings.
- Alarms: Check alarm limits each time the pulse oximeter is used to ensure that they are appropriate for the patient being monitored.
- Loss of pulse signal can occur in any of the following situations:
 - The sensor is too tight.
 - Excessive illumination from light sources such as a surgical lamp, a bilirubin lamp, or sunlight.
 - A blood pressure cuff is inflated on the same extremity as the one with an SpO₂ sensor attached.
 - The patient has hypotension, severe vasoconstriction, severe anemia, or hypothermia.
 - Arterial occlusion proximal to the sensor.
 - The patient is in cardiac arrest or is in shock.

- Sensors:
 - Before use, carefully read the Masimo LNCS[®] sensor directions for use.
 - Use only Masimo oximetry sensors for SpO₂ measurements. Other oxygen transducers (sensors) may cause improper performance.
 - Tissue damage can be caused by incorrect application or use of an LNCS sensor for example, by wrapping the sensor too tightly. Inspect the sensor site as directed in the sensor **Directions for Use** to ensure skin integrity and correct positioning and adhesion of the sensor. When operating at extreme temperatures, take care not to apply the sensor with excessive pressure and monitor application to prevent tissue damage.
 - Do not damage LNCS sensors. Do not use an LNCS sensor with exposed optical components. Do not immerse the sensor in water, solvents, or cleaning solutions (The sensors and connectors are not waterproof). Do not sterilize by irradiation, steam, or ethylene oxide. See the cleaning instructions in the directions for reusable Masimo LNCS sensors.
 - Do not use damaged patient cables. Do not immerse the patient cables in water, solvents, or cleaning solutions (the patient cables are not waterproof). Do not sterilize by irradiation, steam, or ethylene oxide. See the cleaning instructions in the directions for reusable Masimo patient cables.
- Do not use the pulse oximeter sensor during magnetic resonance imaging (MRI) scanning. Inducing current could potentially cause burns. The pulse oximeter may affect the MRI image and the MRI unit may affect the accuracy of the dosimetry measurements.

Batteries

- Only use the power supply provided with the device. Use of any other power supply could cause damage or create a fire and/or destroy the battery and device.
- If you witness a battery or the battery compartment starting to balloon, swell up, smoke, or feel excessively hot, turn off the device, disconnect external power, and observe it in a safe place for approximately 15 minutes and send the device for service. Never puncture or disassemble the battery packs or cells.

User Safety

- Electric shock hazard: Do not remove equipment covers. You may only perform maintenance procedures specifically described in this manual. Refer all servicing to ZOLL or a ZOLL-authorized service center.
- Possible explosion hazard if used in the presence of flammable anesthetics or other flammable substances in combination with air, oxygen-enriched environments, or nitrous oxide.
- This device is not intended for use in explosive atmospheres.
- Pins of connectors identified with the ESD warning symbol should not be touched. Always use precautionary procedures with ESD-sensitive connections.
- Power source installation must only be carried out by qualified service personnel
- Verify integrity of the external power source

Patient Safety

- To ensure patient electrical isolation, connect only to other equipment with electronically isolated circuits.
- Do not place the device or external power supply in any position that might cause it to fall on the patient. Do not lift the device by the power cord, patient circuit, or pulse oximeter patient cable.
- *Never* service the ventilator while in use with a patient.

MR Conditional Equipment

- **Failure to follow all instructions can result in MRI artifacts, injury to the patient or user, or malfunction of the device.**
- **You must follow all safety procedures that are in effect for the MRI Environment. Do not use the ventilator in an MRI Environment with greater than 3T magnetic force.**
 - You must secure the device to a suitable MRI-compatible cart -- ZOLL MRI Roll Stand; Optional IV Arm Assembly.
 - You must place the ventilator behind the 130 Gauss field line (approximately 2 meters to the bore opening of a 3T MRI magnet).
 - The ventilator must be attended by a person with no other responsibility than monitoring the device and patient while in the MRI Environment.
 - You must visually monitor the ventilator for alarms at all times -- during imaging, the alarms may not be audible beyond the area immediately adjacent to the MRI.
- **Danger!** Possible Missile Projection.
 - DO NOT position any person between the bore entrance and an unsecured cart or device.
 - Lock the wheels when the rolling stand is in place.
 - We recommend that you tether the rolling stand in place when in the MRI Environment.
 - Place the ventilator and stand in its position *before* the patient is positioned on the scanner table and advanced into the bore.
 - Remove the patient from the MRI Environment before removing the ventilator and roll stand.
- **Unapproved device apparatus shall NOT be allowed in the MRI Environment, including:**
 - Pulse Oximeters sensors and cabling.
 - External AC/DC Power Supply.
 - Rolling Cart Breathing Circuit Arm.
 - Active Humidification and associated support apparatus.
- **Ensure proper configuration of the ventilator.**
 - DO NOT attach the pulse oximeter sensor to the patient and remove it from the device.
 - The ventilator should run only on battery power in the MRI Environment -- DO NOT use an external AC/DC power supply.
 - The ventilator's battery should be fully charged before entering the MRI Environment.
 - Oxygen Supply -- an aluminum, non-magnetic cylinder and oxygen hose must provide the oxygen supply.
 - Ensure proper operation of the ventilator's breathing system.
 - 12 ft patient circuits are available for use with the ventilator -- the additional length enables a suitable separation between the ventilator and the bore opening. (Adult/Pediatric Wye Patient Circuit; Pediatric/Infant Wye Patient Circuit).
 - The extended tubing length of a 12 ft patient circuit can result in loss of volume due to additional tubing compressibility.
 - Set the Tubing Compliance (C_T) to OFF and ensure that the patient is receiving correct tidal volume.
 - DO NOT use the 12 ft circuit with PEEP settings below 5 cm H₂O (hPa).
 - Ensure that the ventilator is able to maintain PEEP -- for patients with short expiratory times, the additional tubing length of the 12 ft circuit may affect system behavior.

Cautions

- Inspect the circuit every day to ensure that there is no damage or wear that could affect its performance. Remove fluid or other biological material from the circuit or replace the circuit following the local standard of care.
- Federal law restricts this device to sale by or on the order of a physician.
- Only qualified biomedical equipment technicians should service the device.



- Internal components are susceptible to damage from static discharge. Do not remove device covers.
- Possession or purchase of this device does not convey any expressed or implied license to use the device with unauthorized sensors or cables which would, alone, or in combination with this device fall within the scope of one or more of the patents related to this device. ZOLL cannot ensure the proper functioning of this device if it is used with unauthorized sensors, cables, or patient circuits.

FDA Tracking Requirements

U.S. Federal Law (21 CFR 821) requires the tracking of ventilators. Under this law, owners of this ventilator must notify ZOLL Medical Corporation if this product is

- Received
- Lost, stolen, or destroyed
- Donated, resold, or otherwise distributed to a different organization

If any such event occurs, contact ZOLL Medical Corporation in writing with the following information:

- Originator's organization – Company name, address, contact name, and contact phone number
- Model number, and serial number of the ventilator
- Disposition of the ventilator (for example, received, lost, stolen, destroyed, distributed to another organization), new location and/or organization (if known and different from originator's organization) – company name, address, contact name, and contact phone number
- Date when the change took effect

Please address the information to:

ZOLL Medical Corporation
Attn: Tracking Coordinator
269 Mill Road
Chelmsford, MA 01824-04105

Fax: (978) 421-0007
Telephone: (978) 421-9655

Notification of Adverse Events

As a health care provider, you may have responsibilities under the Safe Medical Devices Act (SMDA), for reporting to ZOLL Medical Corporation, and possibly to the FDA, the occurrence of certain events.

These events, described in 21 CFR Part 803, include device-related death and serious injury or illness. In addition, as part of our Quality Assurance Program, ZOLL Medical Corporation requests to be notified of device failures or malfunctions. This information is required to ensure that ZOLL Medical Corporation provides only the highest quality products.

Software License

Note: Read this Operator's Guide and License agreement carefully before operating a ZOLL ventilator product.

Software incorporated into the system is protected by copyright laws and international copyright treaties as well as other intellectual property laws and treaties. This software is licensed, not sold. By taking delivery of and using this system, the Purchaser signifies agreement to and acceptance of the following terms and conditions:

1. **Grant of License:** In consideration of payment of the software license fee which is part of the price paid for this product, ZOLL Medical Corporation grants the Purchaser a nonexclusive license, without right to sublicense, to use the system software in object-code form only.
2. **Ownership of Software/Firmware:** Title to, ownership of, and all rights and interests in the system software and all copies thereof remain at all times vested in the manufacturer, and Licensors to ZOLL Medical Corporation and they do not pass to purchaser.
3. **Assignment:** Purchaser agrees not to assign, sublicense, or otherwise transfer or share its rights under the license without the express written permission of ZOLL Medical Corporation.
4. **Use Restrictions:** As the Purchaser, you may physically transfer the products from one location to another provided that the software/firmware is not copied. You may not disclose, publish, translate, release, or distribute copies of the software/firmware to others. You may not modify, adapt, translate, reverse engineer, decompile, crosscompile, disassemble, or create derivative works based on the software/firmware.

NO IMPLIED LICENSE

Possession or purchase of this device does not convey any express or implied license to use the device with replacement parts which would, alone, or in combination with this device, fall within the scope of one or more of the patents relating to this device.

Limited Warranty

ZOLL warrants the device to be free from all defects in material and workmanship for a period of one (1) year from the date of delivery to the original purchaser.

During the warranty period, ZOLL will repair or replace the device or any part which upon examination is shown to be defective. At its sole discretion, ZOLL may choose to supply a new or equivalent replacement product or refund the amount of the purchase price (on the date sold by ZOLL). To qualify for such repair, replacement, or refund, the defective device must be returned to the ZOLL Service Center within thirty (30) days from the date that the defect is

discovered. This warranty does not apply if the device has been repaired or modified without the authorization of ZOLL or if the damage was caused by incorrect (off-label) use, negligence, or an accident.

Batteries, which by their nature are consumable and subjected to environmental extremes, will be warranted only for a period of ninety (90) days. Accessories, also consumable in usage, such as connecting hose and breathing circuits, are not warranted.

DISCLAIMER OF IMPLIED & OTHER WARRANTIES:

THE PRECEDING WARRANTY IS THE EXCLUSIVE WARRANTY AND ZOLL MAKES NO OTHER WARRANTY OR REPRESENTATION OF ANY KIND WHATSOEVER, EXPRESS OR IMPLIED, WITH RESPECT TO MERCHANTABILITY, FITNESS FOR A PARTICULAR PURPOSE, OR ANY OTHER MATTER. THE REMEDIES STATED IN THIS DOCUMENT WILL BE THE EXCLUSIVE REMEDIES AVAILABLE TO THE CUSTOMER FOR ANY DEFECTS OR FOR DAMAGES RESULTING FROM ANY CAUSE WHATSOEVER AND WITHOUT LIMITATION.

ZOLL WILL NOT IN ANY EVENT BE LIABLE TO THE CUSTOMER FOR CONSEQUENTIAL OR INCIDENTAL DAMAGES OF ANY KIND, WHETHER FOR DEFECTIVE OR NONCONFORMING PRODUCTS, BREACH OR REPUDIATION OF ANY TERM OR CONDITION OF THIS DOCUMENT, NEGLIGENCE, OR ANY OTHER REASON.

Technical Support

If the ventilator requires service, contact the ZOLL Technical Support Department.

| | For customers in the U.S.A. | For customers outside the U.S.A. |
|-----------|------------------------------------|--|
| Telephone | 1-800-348-9011 1-978-421-9655 | Call the nearest authorized ZOLL Medical Corporation representative. |
| Email | techsupport@zoll.com | To locate an authorized service center, contact: ZOLL Medical Corporation 269 Mill Road Chelmsford, MA 01824 Telephone: 1-978-421-9655 techsupport@zoll.com |

When requesting support, please provide the following information to the support representative:

- Ventilator serial number
- Description of the problem, and service code if available
- Department using the equipment and name of the person to contact
- Purchase order to allow tracking of loan equipment
- Purchase order for a device with an expired warranty

Returning a Ventilator for ZOLL Service

Before sending a ventilator to the ZOLL Technical Support Department for repair, obtain a service request (SR) number from the service representative.

The Li-ion battery should remain inside the ventilator. Follow directions provided on the return authorization form.

Pack the ventilator with its power supply in the original shipping containers (if available) or equivalent packaging. Be sure the assigned service request (SR) number appears on each package and follow the Shipping Regulations as described in Chapter 7 of this manual.

Return the device to:

| For customers | Return the device to |
|--------------------|--|
| In the U.S.A. | ZOLL Medical Corporation 269 Mill Road Chelmsford, MA 01824 Attention: Technical Support Department (SR number) Telephone: 1-978-421-9655 |
| In Canada | ZOLL Medical Canada Inc. 1750 Sismet Road, Unit #1 Mississauga, ON L4W 1R6 Attention: Technical Support Department (SR number) Telephone: 1-866-442-1011 |
| In other locations | The nearest authorized ZOLL Medical Corporation representative. To locate an authorized service center, contact the International Sales Department at: ZOLL Medical Corporation 269 Mill Road Chelmsford, MA 01824-4105 Telephone: 1-978-421-9655 |

Chapter 2

Product Overview

This chapter describes ZOLL ventilators and provides more detailed descriptions of the following:

- Ventilator models
- Operating modes support
- Manual Breath and Pressure Plateau support
- Main features
- Controls and indicators
- Display screen
- Fresh Gas/Emergency Air Intake and attachments
- Top Panel
- Pulse Oximeter compatibility
- Power sources
- Pneumatic design
- Oxygen Input
- Patient circuits

Ventilator Models

ZOLL currently offers the following ventilator models:

- Z Vent[®] Basic
- Z Vent
- Z Vent MR
- EMV+[®]
- EMV+ MR
- Eagle II[™]
- Eagle II MR
- AEV[®]

Operating Mode Support

The following table lists the operating mode supported by ZOLL ventilator models.

Note: A more detailed description of the operating modes supported by ZOLL ventilator models including a regional mode reference (outside of the United States) appears in Chapter 4.

| Ventilator Model | Operating Mode Support | | | | | |
|---|------------------------|-------|----------|----------|-------|-----|
| | AC(V) | AC(P) | SIMV (V) | SIMV (P) | CPAP* | BL* |
| Z Vent Basic** | X | X | | | X | X |
| Z Vent, Z Vent MR | X | X | X | X | X | X |
| EMV+ EMV+ MR | X | X | X | X | X | X |
| Eagle II Eagle II MR | X | X | X | X | X | X |
| AEV** | X | X | | | X | X |
| <p>X Mode supported by ventilator model</p> <p>* Spontaneously Breathing Patient Mode</p> <p>** Leak compensation when Mask CPAP selected from Startup Menu</p> | | | | | | |

Manual Breath and Pressure Plateau Feature

The following table lists the availability of Manual Breath and Pressure Plateau features on ZOLL ventilator models.

| Ventilator Model | Manual Breath | Plateau Pressure |
|-------------------------|---------------|------------------|
| Z Vent Basic | X | |
| Z Vent, Z Vent MR | X | X |
| EMV+ EMV+ MR | X | X |
| Eagle II Eagle II MR | X | X |
| AEV | X | |

Ventilator Description

The sections that follow provide a description of the ZOLL ventilators.

Main Features

Figure 2-1 shows the ventilator's main features.

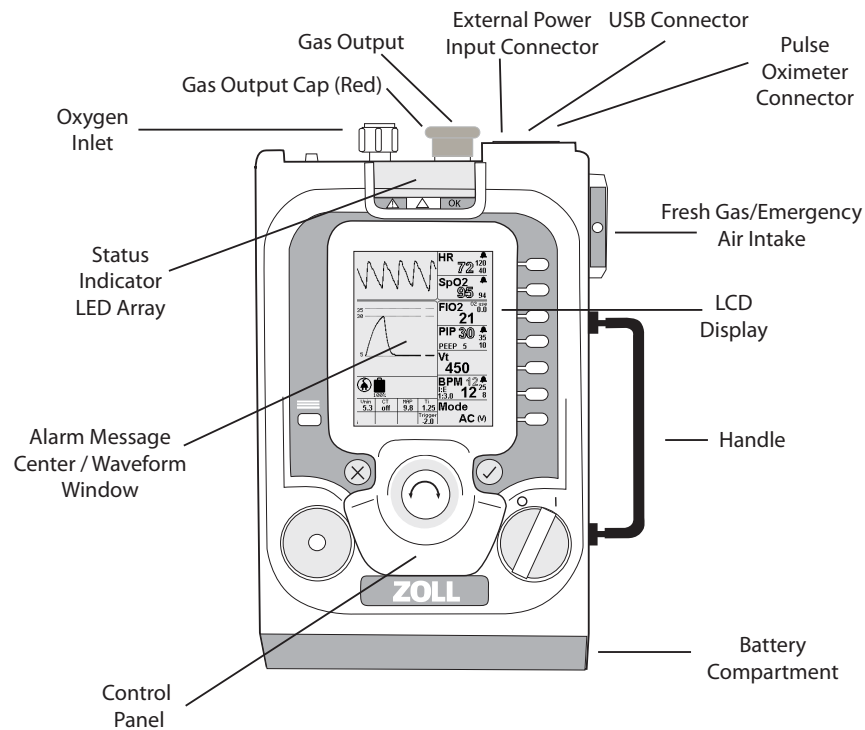

Figure 2-1 Main Features

| Item | Location | Description |
|--------------------------------|----------|---|
| Oxygen Inlet | Top | Enables connection to an external high pressure oxygen source. |
| Gas Output | Top | Enables connection of the patient circuit. |
| Gas Output Cap (RED) | Top | The ventilator is shipped with a red cap covering the Gas Output to protect it from dust and other contaminants. The cap should be saved and reused when the ventilator is stored or not in use. |
| Status Indicator LED Array | Top | Lights to indicate ventilator status and a visible alarm indicator. |
| External Power Input Connector | Top | Enables connection to an external power source. |
| USB Connector | Top | Enables connection to a USB compatible device for servicing the ventilator. |

| Item | Location | Description |
|--------------------------------|----------|---|
| Pulse Oximeter Connector | Top | Enables connection to a pulse oximeter sensor |
| LCD Display | Front | Displays settings, ventilation data, and alarm information. |
| Alarm Message Center | Front | Displays active alarms and alarm mitigation information. |
| Control Panel | Front | Provides user access to the ventilator settings. |
| Battery Compartment | Bottom | Holds the ventilator's rechargeable Li-ion battery. |
| Fresh Gas/Emergency Air Intake | Side | Enables the ventilator internal compressor to use ambient air and acts as an anti-asphyxia valve. |
| Handle | Side | |

Controls and Indicators

The ventilator controls and indicators (shown in Figure 2-2) facilitate ease of use and visibility in all operating environments.

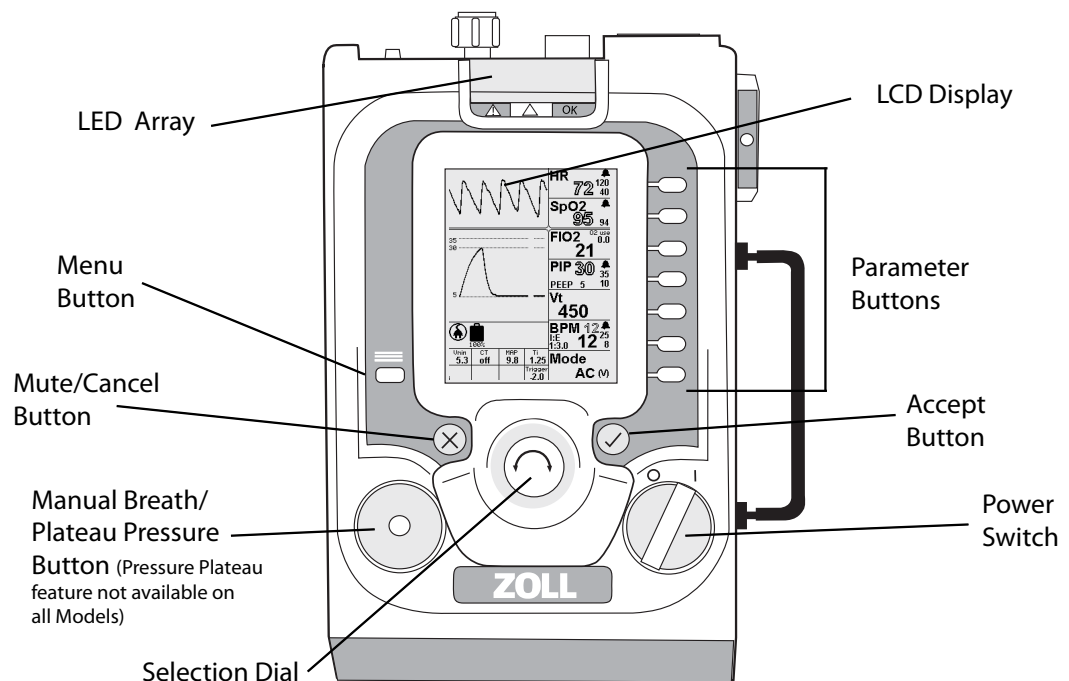

Figure 2-2 Controls and Indicators

Controls

The ventilator's controls consist of the following:

| Control | Function |
|---|--|
| Power Switch | Enables the user to turn the ventilator ON and OFF. |
| Parameter Buttons | Enables the user to access primary parameters, secondary parameters and context menus associated with a primary parameter (if applicable), and then modify settings using the Selection Dial). |
| Menu Button | Enables the user to access the Menu. |
| Selection Dial | Enables the user to set values for a chosen (highlighted) Primary Parameter, Secondary Parameter, Context Menu item, and Menu item. Values accelerate with speed of turning. |
| Mute/Cancel Button | The Mute/Cancel button mutes the audible alarm allowing the user time to change parameters. It can also be used to cancel parameter entries. |
| Accept Button | The Accept button allows the user to accept parameter value settings, acknowledge popup messages, and accept menu choices. |
| Manual Breath Button/ Plateau Pressure | Enables the user to deliver a manual breath and measure Plateau Pressure. Note: Plateau Pressure is an optional ventilator control. If your ventilator supports the Plateau Pressure option, the button is labeled "Manual Breath / P Plat". |

Indicators

The ventilator's indicators consist of the following:

| Indicator | Description |
|-------------|---|
| LCD Display | Displays settings, patient data, and alarm information. |
| LED Array | Indicates operational status (Red, Yellow, or Green). |

Display Screen

The ventilator's display screen has four functional areas as shown in Figure 2-3:

- Alarm Message Center/Waveform Window
- Parameter Windows
- Shared Icon Area
- Auxiliary Parameter Boxes.

These functional areas are discussed in the following sections.

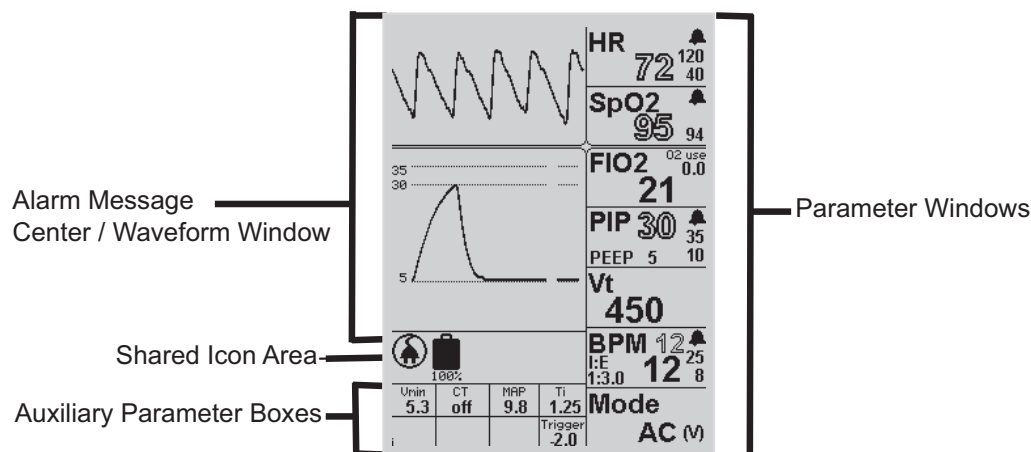

Figure 2-3 Display Screen Functional Areas

Message Area

The display screen's message area can display the following:

- **Airway Pressure and Pleth Waveform Plots** -- Under normal operation (as in the example above), the message area displays plots for airway pressure and, when the pulse oximeter is connected, the Pleth waveform. When a plot is necessary to facilitate a parameter adjustment, the message area displays both the plot and the parameter's context menu.
- **Menus** -- Displays the Menu after you press the Menu button on the ventilator's control panel, or displays a parameter's context menu (which appears after you *press and hold* the associated parameter button on the control panel).
- **Alarms** -- When an alarms occur, the message area displays Smart Help™ messages that identify the alarms and describe possible causes and actions that you can take in response.
- **Popup Windows** -- Display information that assists you when adjusting parameter values.

Parameter Windows

Each parameter window displays its primary parameter and associated secondary parameters, that can include, associated parameters and alarm limits.

Two types of values appear in a parameter window.

- Solid text is used for primary and secondary parameter values you can adjust.
- Outlined text is used for patient-dependent measured values.

Chapter 4, "Using the Ventilator" contains more information and instructions for adjusting parameter values.

Shared Icon Area

Directly below the message area, the device displays icons that indicate

- The ventilator's power source (operating on external power or its battery)
- The battery charging status
- An oxygen supply is attached
- Alarms are muted or audible

Auxiliary Parameter Boxes

Some parameters have values that the ventilator displays in the parameter boxes at the bottom of the display screen. You can adjust these values using the parameter's context menu.

Fresh Gas/Emergency Air Intake and Attachments

The Fresh Gas/Emergency Air Intake is located on the side of the ventilator as shown in Figure 2-4.

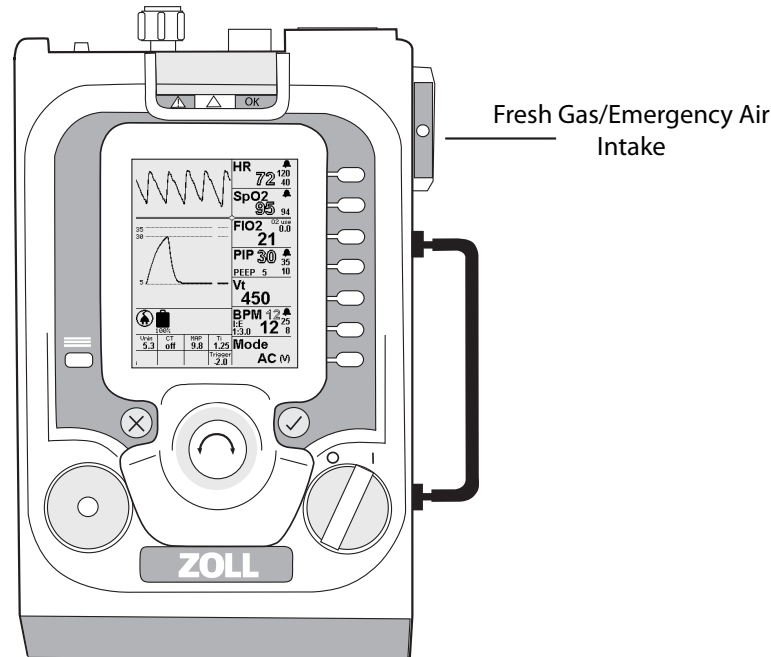

Figure 2-4 Fresh Gas/Emergency Air Intake

The Fresh Gas/Emergency Air Intake allows ambient air into the device's internal compressor. The intake also acts as an anti-asphyxia valve that enables the patient to breathe ambient air should the ventilator fail. The Fresh Gas/Emergency Air Intake contains a disk filter and permits the user to connect either a bacteria/viral or a chemical/biological filter depending on ambient conditions.

An Oxygen Reservoir Kit is attached to the Fresh Gas/Emergency Air Intake to allow low flow oxygen use with the ventilator to provide supplemental oxygen to patients, an ISO 5362 compliant breathing bag is attached with to a manifold which is connected to a low flow oxygen source (either an oxygen flow meter or oxygen concentrator).

Oxygen is delivered through the Fresh Gas/Emergency Air Intake when the device's internal compressor cycles to deliver a breath.

Oxygen Reservoir Kit (Optional)

The Oxygen Reservoir Kit serves the following purposes:

- Acts as a reservoir, collecting oxygen during the expiratory phase of ventilation.
- Provides an interface to the ventilator and the attachment of the low-flow oxygen supply hose.
- Provides an inlet in the event the low-flow oxygen supply fails or the tidal volume is greater than the supplied oxygen.

See Chapter 3 for more information about using low flow oxygen sources.

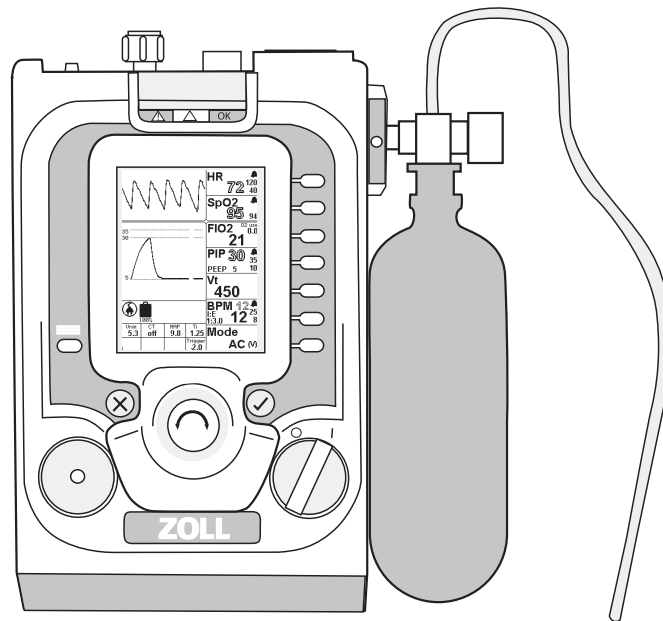

Figure 2-5 Ventilator with O₂ Reservoir Kit

Top Panel

The oxygen hose, patient circuit, external power, and pulse oximeter attach to the top panel of the ventilator. The USB port is only used when servicing the device. The ventilator top panel appears as shown in Figure 2-6.

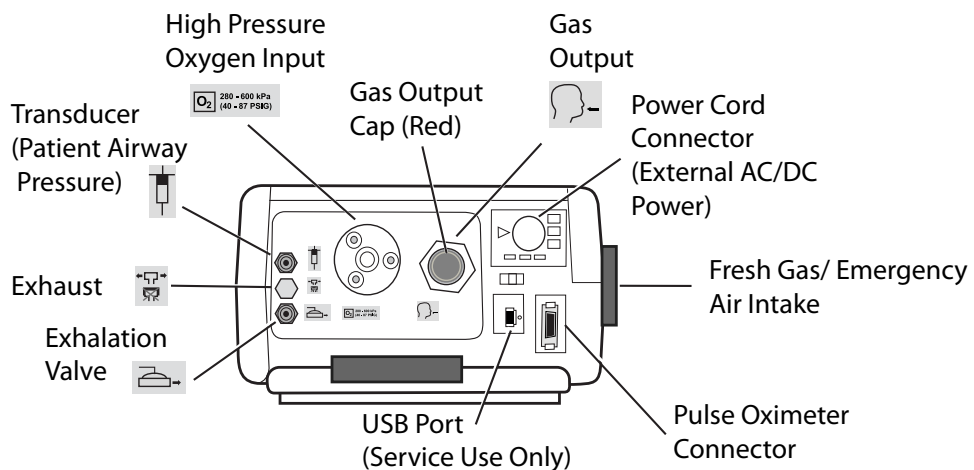

Figure 2-6 Top Panel

Note: The ventilator is shipped with a red cap covering the Gas Output (called out in Figure 2-6) to protect it from dust and other contaminants. The red cap should be saved and reused when the ventilator is stored or not in use.

Pulse Oximeter Compatibility

The ventilator can accommodate an optional connection of external Masimo Pulse Oximeter. When the appropriate sensor is connected, the pulse oximeter provides continuous noninvasive monitoring of the oxyhemoglobin saturation (SpO₂) and pulse rate (measured by the SpO₂ sensor) for adult, pediatric and infant patients.

The Masimo LNCS series of probes are approved for use with the ventilator. The Accessory table in Appendix A lists the sensors which are available for use with the ventilator.

Power Sources

The ventilator can operate using external power or it can operate powered by its internal Li-ION battery.

The external AC/DC Power cable is a universal supply that can operate with an input of 100 to 240 VAC 50/60 Hz.

The external AC/DC Power cable that ZOLL provides with the ventilator delivers a DC input to the device of 24 V at 5 A. When this external power source is present, the ventilator automatically charges its internal battery while operating.

Only use an approved external power supply provided with the ventilator when connecting to AC power.

Operating Using External DC Power

The ventilator can also operate using external DC power. When connected to a standard vehicle DC outlet using either the 12 or 28 VDC Power Cable that ZOLL offers, the ventilator automatically charges its internal battery while operating. The input DC supply is monitored and the ventilator issues alarms for the following conditions:



- Insufficient current
- High voltage
- Disconnect/ low voltage
- DC reversed

Note: The input connector of the ventilator accepts DC voltages between 11.8 to 30.3 VDC.

Caution When using the standard vehicle DC outlet, do not jump start the vehicle during operation of the ventilator.

Only ZOLL approved power supplies can be used with the ventilator.

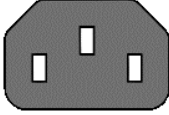
The ventilator includes the external power supply as part of the safety assessment. The power supply contains the system's safety barrier and is classified for the ZOLL Ventilator as follows:

| Classification | Power Supply Connector and Label | Line Cord Wall Plug |
|---|---|-----------------------|
| Class I |  <p>INPUT: 100 - 240V ~ 1.27-0.55A 50/60Hz (or 400 Hz) OUTPUT: +24 VDC ----- 4.4A</p> <p>Means of protection: Safety Ground Power Supply – C6 Receptacle</p> <p>Suitable for use in aircrafts.</p> <p>A power supply holder kit is available. Use of a Class I power supply in an EMS environment requires the use of the power supply holder.</p> | 3 Prong NEMA 5-15P |
| Class I |  <p>INPUT: 100 - 240V ~, 50-60 Hz, 2.5 A (2.5 A-1.5 A) OUTPUT: +24 VDC ----- 5.0 A</p> <p>Means of Protection: Safety Ground Power Supply – C14 Receptacle</p> <p>Not for use in an EMS environment.</p> | 3 Prong NEMA 5-15P |
| Class II |  <p>INPUT: 100 - 240V ~, 50-60 Hz, 2.5 A (2.5 A-1.5 A) OUTPUT: + 24 VDC -----, 5.0 A</p> <p>Means of Protection: Double insulation</p> <p>Power Supply - C8 Receptacle</p> <p>Not for use in aircrafts.</p> | 2 Prong NEMA 1-15P |
| Mains protection is ensured up to 16,400 ft (5,000 m), or cabins pressurized to at least 54kPa. | | |

The device safety testing has been performed in accordance to IEC-60601-1 for each supply and is an approved alternate configuration.

Operating Using Battery Power

When an external power failure occurs, the ventilator automatically switches to its internal battery for operating power and activates the External Power Fault alarm; there is no interruption in operation. When external power returns, operating power automatically switches to the external power source and the following symbol displays on the ventilator screen as shown in Figure 2-7.

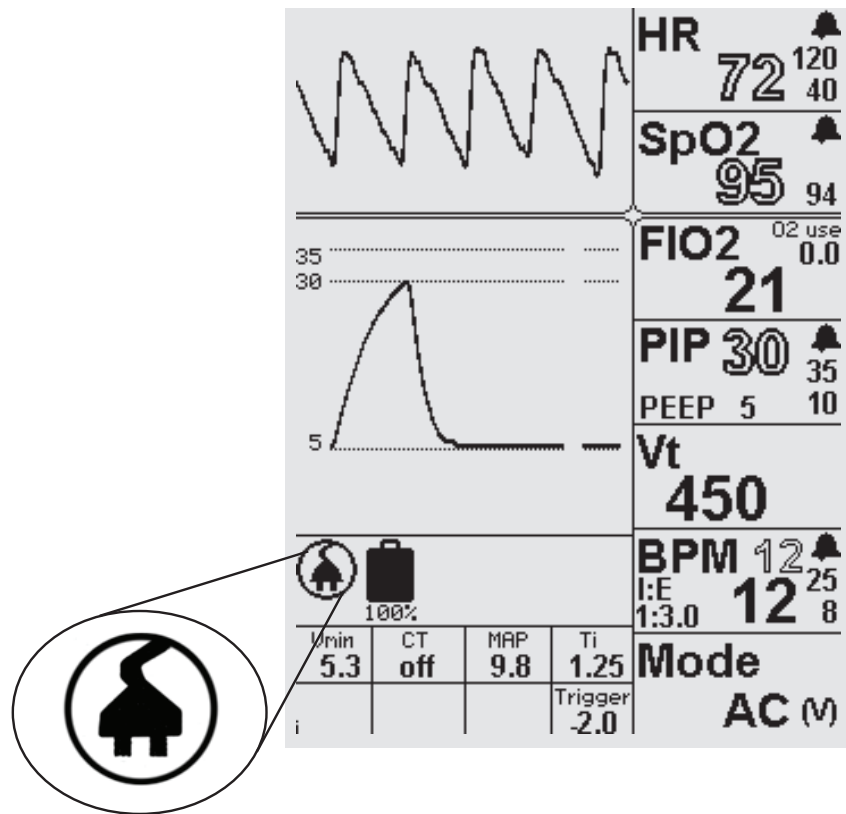

Figure 2-7 External Power GUI Symbol

In the event that the ventilator needs to be shutdown, turn the POWER switch to the OFF (“O”) position. If this fails to work or puts the patient or user at possible risk, disconnect the device from the external power source.

Pneumatic Design

The ventilator includes an oxygen valve and a compressor to provide the appropriate gas mixture for the patient. The system includes transducers for pressure measurements including O₂ input supply and barometric pressure.

The Wye circuit is part of the ventilator’s pneumatic system. The inspiratory side of the wye circuit provides gas to the patient. The expiratory side exhausts directly to atmosphere without returning to the ventilator. The ventilator pneumatically controls the exhalation valve (to maintain PEEP) and a transducer within the ventilator measures the airway pressure.

The ventilator breath transitions from expiratory to inspiratory phase is triggered by patient effort (negative pressure) or time. The breaths are time or flow cycled and can either be pressure or volume (flow) targeted.

Figure 2-8 depicts a diagram of the ventilator’s pneumatic design.

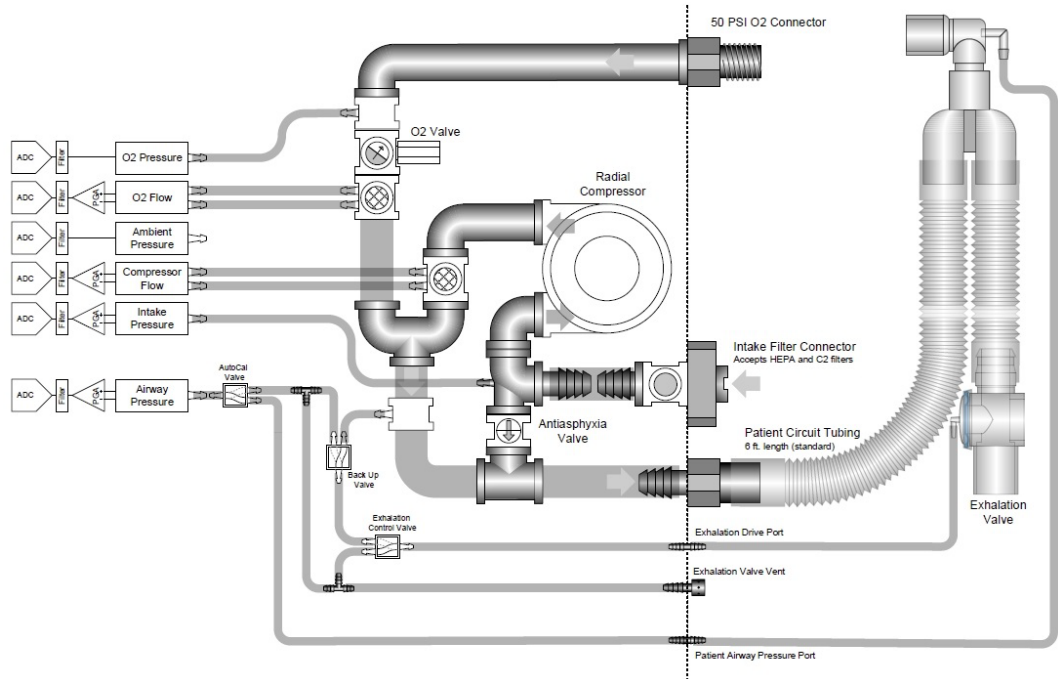

Figure 2-8 Pneumatic Design

Oxygen Input: High Pressure Gas Supply

An external high pressure gas source connects to the ventilator using the high pressure oxygen input port. The device attaches to a regulated medical grade (USP) O₂ system or O₂ cylinder supply of 40 to 87 psig (280 to 600 kPa). Maximum flow rate of the oxygen supply is 100 liters per minute. The Oxygen Input fitting (See Figure 2-9) has a male oxygen Diameter Index Safety System (DISS) thread.

Note: If external oxygen is connected, the oxygen pressure must be at least 41 psig (± 2 psig) (283 kPa (± 14 kPa)) at the time the ventilator performs its Self-Check after turning on the ventilator.

High Pressure Oxygen Supply Hose

A standard oxygen hose is available for connecting the ventilator to a high pressure oxygen source. (Also see Chapter 6 “Operating Environments”). Hoses are available from ZOLL, or a suitable alternative as described below can be used as indicated.

| High Pressure Oxygen Hose for compliance with ISO standard (ISO STANDARD 5359) | | |
|--|---|------------------------------|
| Ventilator Side Connections | Hose Attributes | Supply Side Connections |
| DISS | 6 ft (maximum 20 ft) Green or White (as determined by local regulations) non-conductive | Quick Disconnect, DISS, etc. |

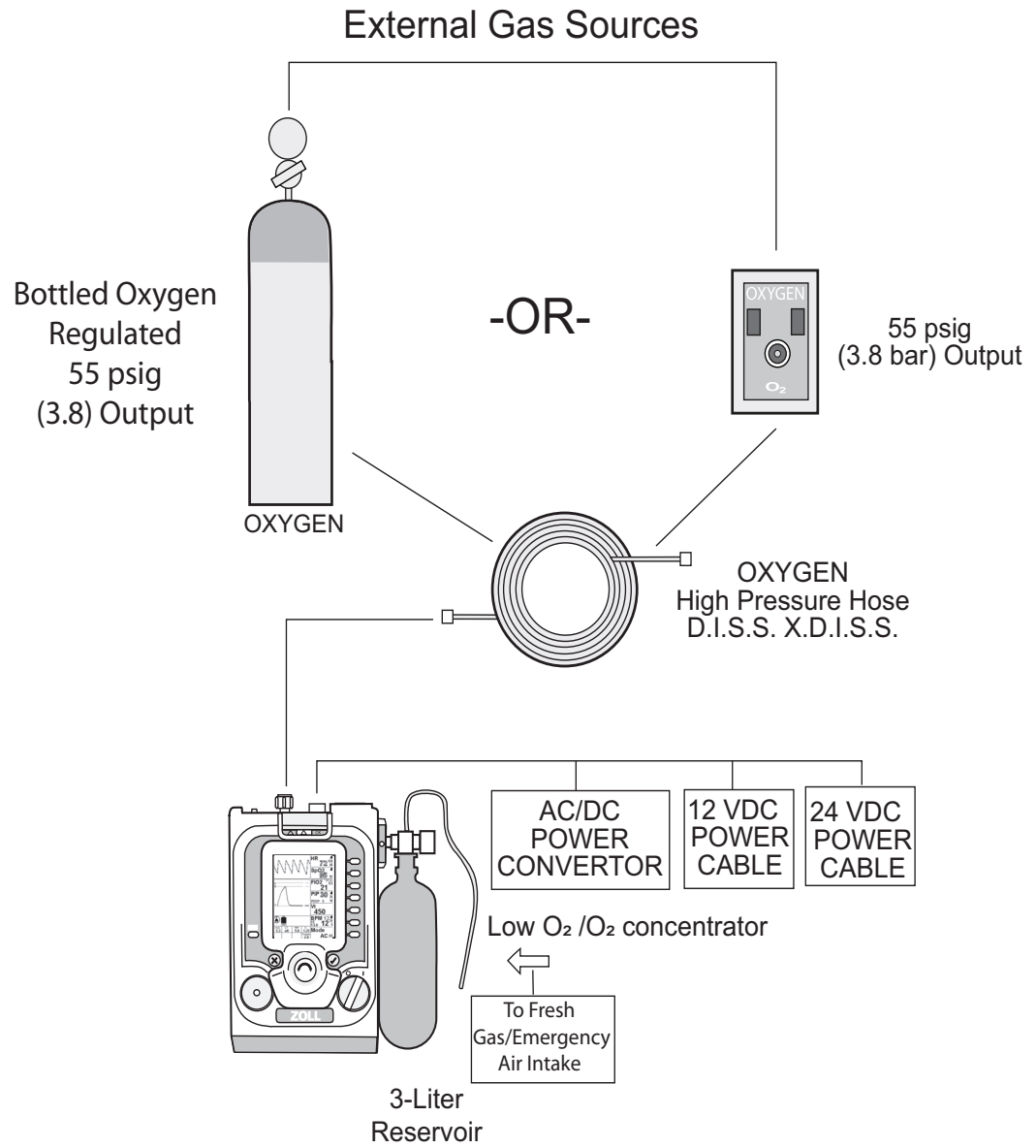

Figure 2-9 Ventilator Gas Sources

Patient Circuits

The ventilator can use 6 ft or 12 ft patient circuits (see Figure 2-10) to support adult, pediatric, and infant patients.

Note: Troubleshooting information regarding patient circuits is found in Appendix D.

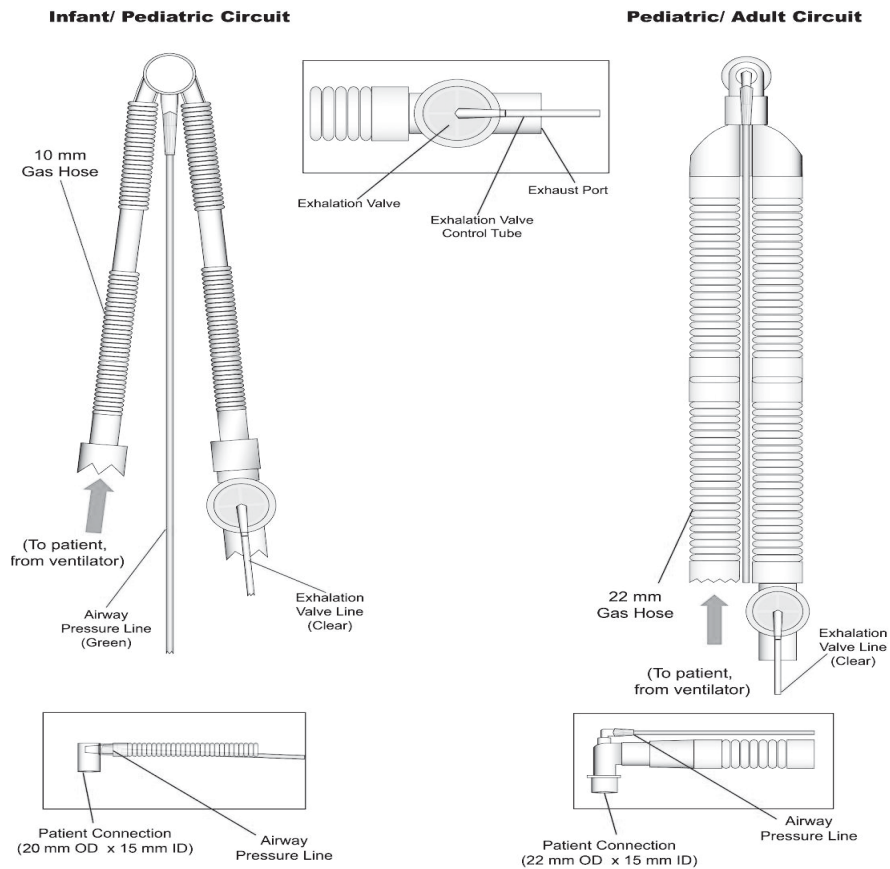

Figure 2-10 Patient Circuits

ZOLL provides the following circuit types:

- Pediatric/Adult, 6 ft and 12 ft
- Infant/Pediatric, 6 ft and 12 ft

Always dispose of disposable circuits after single patient use following the institutional guidelines for biologically contaminated material. Reusing a disposable circuit can result in cross contamination between patients.

Intended Use

The pediatric/adult patient circuits are intended for use when delivering tidal volume from 200 ml to Adult.

The infant/pediatric patient circuit is intended for use when delivering tidal volume from 50 ml to 300 ml.



Warning! **Patient circuits marked as such are non-sterile and intended for Single Patient Use Only**

Caution During use the circuit may come into contact with biohazard material. Handle carefully to avoid cross-contamination.

Not intended for use with heated humidifier.

Note: ZOLL Medical Corporation recommends that you examine the patient circuit on a daily basis for damage or wear, such as cracking, discoloration, or disfigurement. If there is any sign of physical degradation or if the ventilator has patient circuit alarm conditions replace the patient circuit.

Use of Heat and Moisture Exchangers

Heat and Moisture Exchangers (HMEs) can be used with the device. The HME provides heat and moisture to the inspired gas by recycling the heat and moisture contained in the patient's exhaled gas. While HMEs may not be suitable for all applications, they facilitate portability in a way that conventional humidifiers cannot. The device can be used with an optional HME or an optional HME/bacterial viral filter (HMEF). Be sure to follow all instructions provided by the manufacturer.

Note: Use of the HME will cause a slight increase in the inspiratory and expiratory resistance. Always monitor the patient and adjust the ventilator as needed.

ZOLL does not offer a heated humidification option for the device.

Warning! **Users should use the appropriate HME for the patient's size. Failure to do so can result in excessive dead space and lead to hypercapnia and hypoxia.**

Attaching a Patient Circuit to the Ventilator

Figure 2-11 shows how to attach a patient circuit to the ventilator.

Adult Circuit

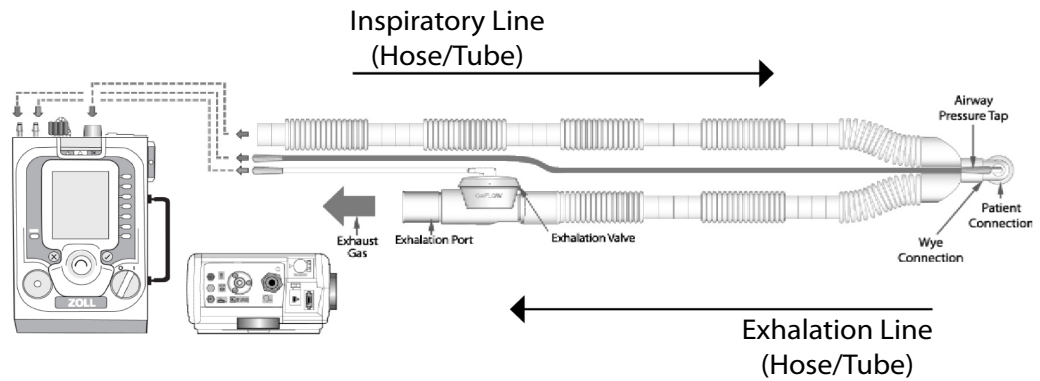

Infant/Pediatric Circuit

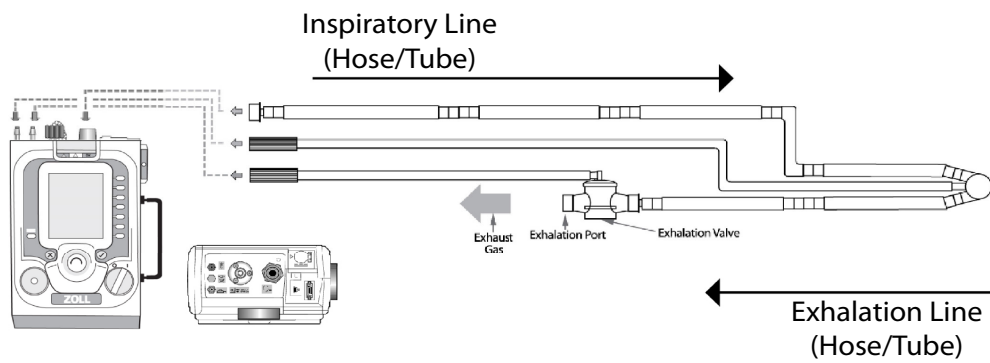
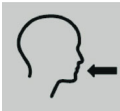





Figure 2-11 Patient Circuit Attachment

The list that follows identifies the circuit connections.

| Connection | Symbol on the Ventilator | Description |
|------------------------------|---|-------------|
| Inspiratory Line (Hose/Tube) |  | Gas Output |
| Pressure Line (Green) |  | Transducer |

| Connection | Symbol on the Ventilator | Description |
|-------------------------|---|-----------------------------|
| Exhalation Line (Clear) |  | Exhalation Valve |
| Oxygen In |  | High Pressure Oxygen Outlet |
| Exhaust |  | Do Not Occlude |

Specifications

Note: 1 cm H₂O equals .98 hPa.

Pediatric/Adult, 6 ft Patient Circuit

The Pediatric/Adult, 6 ft patient circuit has the following specifications:

- Internal Diameter: 22 mm
- Inspiratory Resistance: R_{INSP} @ 30 Lpm: 0.01 cm H₂O/l/min
- Expiratory Resistance: R_{EXP} @ 30 Lpm: 0.10 cm H₂O/l/min
- Tubing Compliance: C_T @ 60 cm H₂O: 1.6 ml/cm H₂O
- Dead Space: 22 ml
- Maximum Working Pressure: 100 cm H₂O

Pediatric/Adult, 12 ft Patient Circuit

The Pediatric/Adult, 12 ft (3.7 m) patient circuit has the following specifications:

- Internal Diameter: 22 mm
- Inspiratory Resistance: R_{INSP} @ 30 Lpm: 0.02 cm H₂O/l/min
- Expiratory Resistance: R_{EXP} @ 30 Lpm: 0.10 cm H₂O/l/min
- Tubing Compliance: C_T @ 60 cm H₂O: 2.8 ml/cm H₂O
- Dead Space: 22 ml
- Maximum Working Pressure: 100 cm H₂O

Infant/Pediatric, 6 ft Patient Circuit

The Infant/Pediatric, 6 ft patient circuit has the following specifications:

- Internal Diameter: 10 mm
- Inspiratory Resistance: R_{INSP} @ 15 Lpm: 0.11 cm H₂O/l/min
- Expiratory Resistance: R_{EXP} @ 15 Lpm: 0.17 cm H₂O/l/min
- Tubing Compliance: C_T @ 60 cm H₂O: 0.5 ml/cm H₂O
- Dead Space: 4.2 ml
- Maximum Working Pressure: 100 cm H₂O

Infant/Pediatric, 12 ft Patient Circuit

The Infant/Pediatric, 12 ft patient circuit has the following specifications:

- Internal Diameter: 10 mm
- Inspiratory Resistance: R_{INSP} @ 15 Lpm: 0.17 cm H₂O/l/min*
- Expiratory Resistance: R_{EXP} @ 15 Lpm: 0.17 cm H₂O/l/min
- Tubing Compliance: C_T @ 60 cm H₂O : 0.8 ml/cm H₂O
- Dead Space: 4.2 ml
- Maximum Working Pressure: 100 cm H₂O

Note: The extended length of the tubing in the 12 ft (3.7 m) circuit results in a higher R_{INSP} compared to the 6 ft circuit.

Warning! Compressible volume can significantly decrease the delivered tidal volume. When managing patients at risk, always correct for compressible volume Use the Vt Context Menu to adjust Tubing Compliance and Compressible Volume Measurements.

Warning! Do not use the 12 ft circuit with PEEP settings below 5 cm H₂O (hPa).

Warning! Given the additional length of the 12 ft circuit, the system may not be able to trap PEEP in patients with short expiratory time. Always ensure that the device is performing as required.

Chapter 3

Setting Up the Ventilator

This chapter describes how to set up the ventilator. It lists the tasks required to set up the ventilator for safe, effective use, and describes each task in detail.

Warning! **You must properly set up the ventilator before use. Failure to do so can result in inadequate care or death of the patient.**

To set up the ventilator, you must perform the following tasks:

1. Attach the patient circuit
2. Attach the high pressure oxygen supply (optional)
3. Inspect Fresh Gas/Emergency Air Intake filter
4. Connect Fresh Gas/Emergency Air Intake attachments (optional)
5. Select the ventilator's power source
6. Turn on the ventilator
7. Select Start Up default configurations
8. Change the operating mode (optional)
9. Change parameter values
10. Perform an operational test
11. Attach the pulse oximeter (optional)
12. Attach patient

We describe how to perform these tasks in the following sections of this chapter.

Warning! Always follow physicians orders and local protocols that includes preparations to manually ventilate (bag) the patient. Ensure there is a functioning Bag Valve Mask available to support the patient in the event of a ventilator failure. DO NOT start up the ventilator with the patient attached.

1. Attach the Patient Circuit

Select the correct patient circuit for the patient and environment (as we describe in the previous chapter). Always follow the instructions included with the circuit. Attach the patient circuit to the ventilator's top panel as follows. See Figure 3-1.

1. Remove the red cap covering the Gas Output, then connect the patient circuit (corrugated hose) to the ventilator's Gas Output
2. Connect the green 3/16 inch ID airway pressure line to the pressure transducer
3. Connect the clear 1/4 inch ID exhalation valve control line to the exhalation valve fitting.
4. Connect the oxygen hose to the Oxygen Input connector.

Note: The patient circuit recommended temperature range for use is -40 to 70 °C (-40 to 158 °F).

Note: The ventilator is shipped with a red cap covering the Gas Output (called out in Figure 2-6) to protect it from dust and other contaminants. The red cap should be saved and reused when the ventilator is stored or not in use.

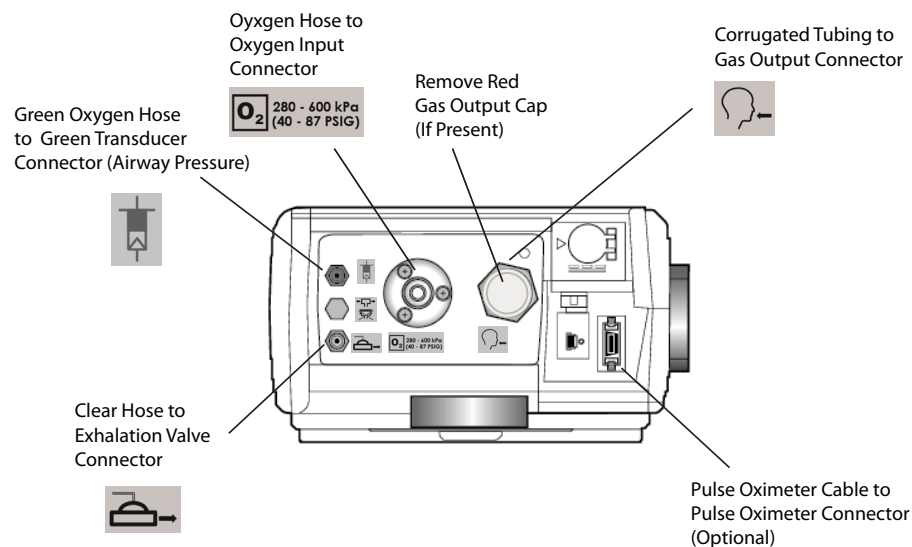

Figure 3-1 Patient Circuit Device Connections

Warning! Adult patients should only be ventilated with Pediatric/Adult circuits. Infant patients should only be ventilated with Infant/Pediatric circuits.

Warning! ZOLL recommends the use of the patient circuits that ZOLL offers for the ventilator. If circuits with different resistance/compliance are used or additional accessories are placed in line with the circuit, you must use the appropriate compliance factors for the new circuit, and make sure the dead space volume of the added accessories are considered so that the device delivers an effective tidal volume to the patient.

Warning! Use of a facemask adds dead space, always ensure the dead space of the system (patient circuit plus facemask) is appropriate for the patient you are supporting.

2. Attach the High Pressure Oxygen Supply (Optional)

Since the ventilator includes an internal compressor, the attachment of a high pressure oxygen supply is optional. Review the high pressure supply requirements that we describe in Chapter 2, and use the oxygen hose to attach the ventilator's oxygen inlet to the high pressure O₂ source. The ventilator oxygen inlet is shown in Figure 3-2.

Warning! Use only with medical-grade (USP) oxygen. When using with an oxygen cylinder, the cylinder must be secured. The O₂ hose is either colored green or white, depending on country specifications.

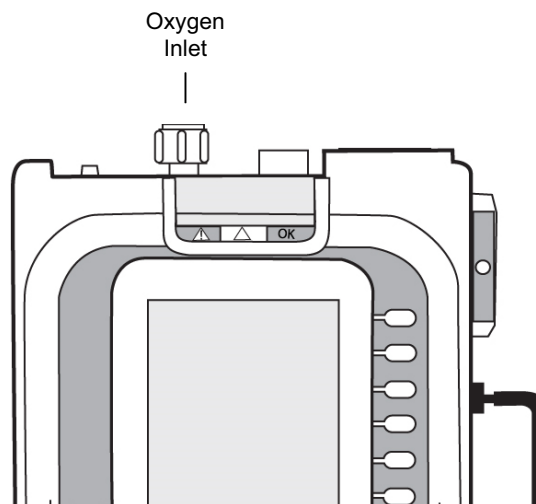

Figure 3-2 Oxygen Inlet

3. Inspect Fresh Gas/Emergency Air Intake Filter

The Fresh Gas/Emergency Air Intake provides the gas path for the ventilator's internal compressor. The built-in filter protects the compressor and patient from particulate matter (a Fresh Gas/Emergency Air Intake disk filter).

The ventilator's Fresh Gas/Emergency Air Intake is shown in Figure 3-3. Inspect the filter and, if dirty, replace it (See the section, "Replacing Ventilator Filter" in Chapter 7).

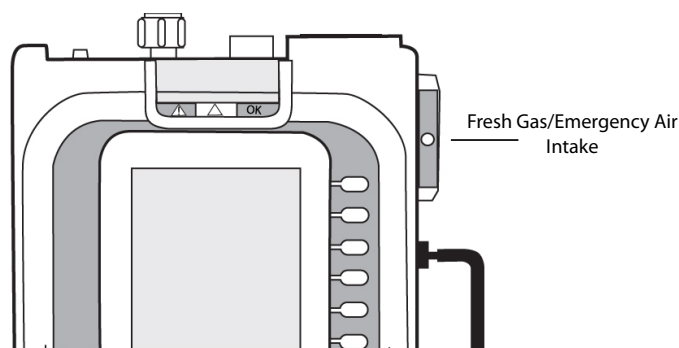

Figure 3-3 Fresh Gas/Emergency Air Intake

Warning! Never block the Fresh Gas/ Emergency Air Intake, free flow of air is required during compressor operation or in the event of device failure to allow spontaneous breathing. The Fresh Gas/Emergency Air Intake also acts as an anti-asphyxia port in the event of a ventilator failure.

4. Connect Fresh Gas/Emergency Air Intake Attachments (Optional)

The operating environment of the ventilator may require you to connect the following attachments to the Fresh Gas/Emergency Air Intake:

Oxygen Reservoir Kit

If the ventilator will use oxygen from low-flow sources, you may choose to attach an Oxygen Breathing Bag (compliant with ISO 5362). Follow these steps:

1. Press the **Menu** button and use the **Dial** to choose O₂ Reservoir "On". This tells the ventilator that the reservoir is attached and prevents the Intake Restricted alarm from sounding.
2. Attach the Oxygen Reservoir Kit to the Fresh Gas/Emergency Air Intake. This port is located in the side of the ventilator. It will be necessary to use a 22 mm male-to-male adapter (with hose barb) with 731 Series Ventilators.
3. Connect the O₂ supply tubing between the O₂ source and the hose barb on the adapter.
4. Adjust the O₂ flow to achieve an acceptable O₂ saturation.

Note: The assembly will function when the reservoir bag is hanging down or lying horizontally provided the bag does not fall in such a way that occludes the neck of the bag. The ventilator will sound a low priority Intake Restricted alarm if the menu has not been changed (see “1” above). Operating with the alarm active does not affect the ability of the ventilator to deliver breaths at the current settings. It is to alert the user that a restriction has been detected at the inlet. Always allow 5 to 10 minutes between adjustments to assure the patient oxygenation has stabilized. This is very important when decreasing the O₂ supply where it may take several minutes for a patient to stabilize at the new O₂ flow. Never use O₂ flows > 10-12 liters/min. Flows greater than this can cause the baseline pressure to drift, waste oxygen, and may cause an Auto-PEEP alarm.

Warning! Always monitor the patient's oxygenation using a pulse oximeter. The O₂ flow from a concentrator or other O₂ source may not be adequate to achieve the desired SPO₂ target. Failure to follow the Instructions and WARNINGS provided with the O₂ Reservoir could result in an adverse effect on the patient.

Note: Due to the slight difference between the densities of air and O₂, the tidal volume will decrease slightly as O₂ is entrained. The worst case is a < 10% decrease in tidal volume when the entrained O₂ results in FIO₂ of 100%.

The table below shows both the affect on tidal volume and the resultant FIO₂ supply rate.

| Ventilator | AC 12, Vt 700, PEEP 5, I:E 1:2.5 | | | | | | | | |
|---------------------|----------------------------------|------|------|------|------|------|------|------|------|
| O ₂ Flow | 0 | 1 | 2 | 3 | 4 | 5 | 6 | 7 | 8 |
| FIO ₂ | 21 | 30 | 38 | 48 | 57 | 70 | 80 | 89 | 100 |
| Vt (set) | 740 | 732 | 725 | 718 | 711 | 703 | 691 | 689 | 682 |
| Vt (actual) | 700 | 692 | 685 | 678 | 671 | 663 | 651 | 649 | 642 |
| % Chg | 0 | -1.1 | -2.1 | -3.1 | -4.1 | -5.3 | -7.0 | -7.3 | -8.3 |
| | AC 12, Vt 500, PEEP 5, I:E 1:2.5 | | | | | | | | |
| O ₂ Flow | 0 | 1 | 2 | 3 | 4 | 5 | 6 | | |
| FIO ₂ | 21 | 30 | 43 | 56 | 69 | 89 | 100 | | |
| Vt (set) | 527 | 523 | 514 | 506 | 502 | 493 | 486 | | |
| Vt (actual) | 500 | 496 | 487 | 479 | 475 | 466 | 459 | | |
| % Chg | 0 | -0.8 | -2.6 | -4.2 | -5.0 | -6.8 | -8.2 | | |
| | AC 18, Vt300, PEEP 5, I:E 1:2.5 | | | | | | | | |
| O ₂ Flow | 0 | 1 | 2 | 3 | 4 | 5 | 6 | | |
| FIO ₂ | 21 | 32 | 47 | 62 | 76 | 96 | 100 | | |
| Vt (set) | 312 | 307 | 303 | 299 | 298 | 291 | 287 | | |
| Vt (actual) | 300 | 295 | 291 | 287 | 286 | 279 | 275 | | |
| % Chg | 0 | -1.7 | -3.0 | -4.3 | -4.7 | -7.0 | -8.3 | | |

Bacterial/Viral (BV) Filter

If the ventilator will operate in an environment where the patient is at risk from cross contamination or airborne pathogens, you may choose to attach a BV filter (See Chapter 6, “Operating Environments” for more information on this filter).

Chemical/Biological C2A1 Filter

If the ventilator will operate in a contaminated environment, you may choose to attach a chemical/biological C2A1 filter obtained from a Chemical/Biological Filter supplier.

Connect the filter canister directly to the device or use an approved adapter.

Note: ZOLL does not offer this filter. (See Chapter 6, “Operating Environments” for more information on this filter).

Warning! Always monitor the patient and ventilator when using external filters or the external O₂ reservoir. Changing modes can trigger false compressor failure alarms when the device’s parameter configurations requires very high air flow.

5. Select the Ventilator’s Power Source

The ventilator can run using one of the following power sources:

- Fully charged, the battery provides 10 hours of operation at factory default settings with pulse oximeter operating at 77 °F.
- External AC/DC Power Supply (See Chapter 2).
- External DC power from a standard vehicle DC outlet using either the 12 or 28 VDC Power Cable that ZOLL provides to connect the ventilator to the DC outlet. The ventilator’s input connector accepts DC voltages between 11.8 to 30.0 VDC.

The ventilator uses external power when available rather than its internal battery pack. When an acceptable external power source is present, the ventilator automatically charges the internal battery while the device operates. When an external power failure occurs, the device automatically switches to its internal battery for operating power and activates the External Power Fault alarm; there is no interruption in operation or loss of any alarms. When external power returns, operating power automatically switches from internal power to the external source.

In the event that the device needs to be shutdown, turn the **Power** switch to the OFF (“O”) position. If this fails to work or puts the patient or user at possible risk, disconnect the device from the mains power.

To connect the ventilator to an external power source, connect an AC/DC Power Supply plug to the device’s External Power Input and an acceptable electrical outlet.

Connecting the Power Supply

Connect the external power cable to the ventilator as described in Figure 3-4 and Figure 3-5.

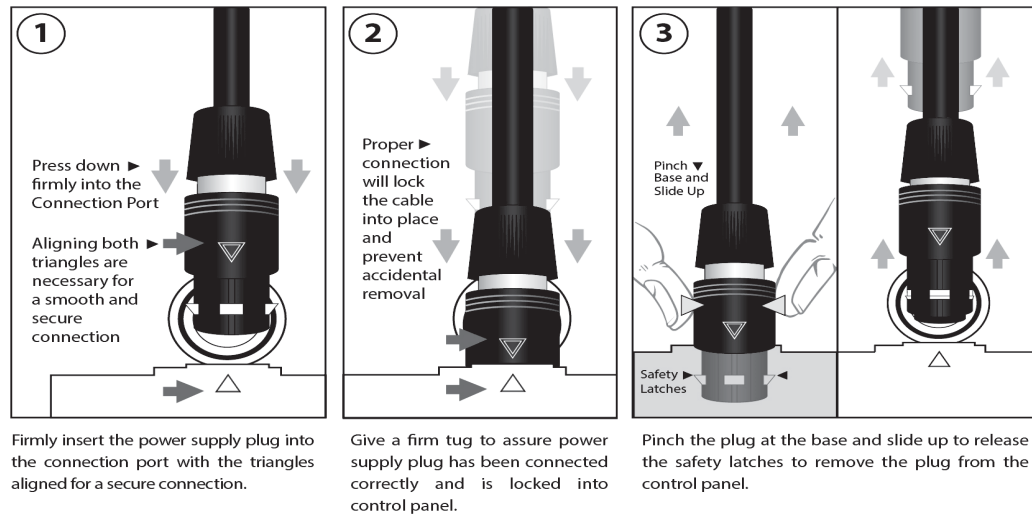

Figure 3-4 Connecting and Disconnecting the Power Supply

Warning! If the power supply, power cable, or power connection plugs are damaged or become damaged during use, immediately disconnect the power cable from external power and the device.

Caution Do not twist the power cable connection plug. Pinch the plug and slide up to release the safety latches. Failure to do so may damage the power connection plug and prevent it from functioning.

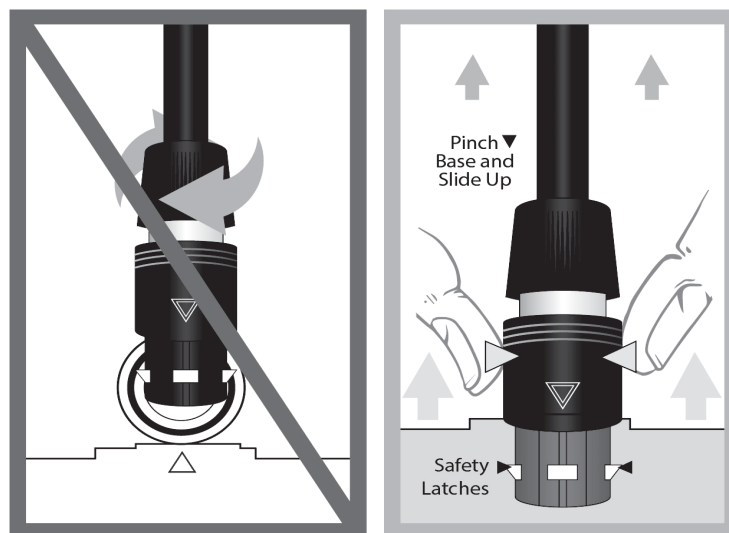

Figure 3-5 Power Supply Latching

6. Turn On the Ventilator

To turn on the ventilator, turn the Power switch to “I”. Figure 3-6 shows the location of the ventilator’s power switch.

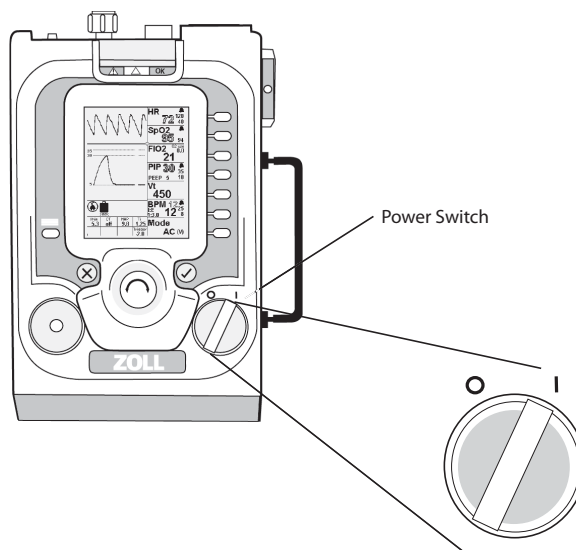

Figure 3-6 Power Switch

After turning on the ventilator, the device performs its Self-Check test, which checks for alarm conditions and the operation of the pneumatic system, internal communications, and power system. After completing the Self-Check test, the ventilator waits for the user to select a starting configuration before it begins to operate. Once operation begins, the ventilator continuously monitors for alarm conditions.

During normal start-up, the ventilator’s alarms are muted for 2 minutes (120 seconds) to allow you to connect the patient circuit, pulse oximeter, adjust ventilator settings, and perform an operational test without distraction. The start-up mute self clears when there are not any active medium priority alarms and no unmuted low priority alarms for a period of 15 seconds.

Warning! Always start the ventilator, select the patient settings, ensure operation, and then connect the patient. Always manually ventilate the patient when they are not connected to the ventilator.

7. Select Start Menu Option

When you turn on the ventilator, the Start Menu appears, from which you choose an appropriate starting configuration for the patient. You can select from these patient defaults:

- Adult
- Pediatric
- Mask CPAP -- Continuous Positive Airway Pressure (CPAP)
- Custom -- Values saved in a previous session
- Last Settings -- Values set for the last patient treated before turning OFF the ventilator

Note: Gas flow at start up is used to detect the patient in event proper procedures are not followed.

Warning! **Default settings are intended to speed the configuration of the ventilator. Particular care should be taken to adjust the ventilator appropriately before ventilating infants and children. The ventilator should always be adjusted before placing the patient on the ventilator.**

The predefined configurations (Adult, Pediatric, Mask CPAP) are default settings defined within the specified use. The Custom default can be used to define a configuration that supports your use and/or patient population. See Chapter 4 for more information.

To select the device's default parameter values, highlight one of the above settings in the **Start Menu** and press the **Accept** button. To operate with parameter values that differ from the default values, use the device's parameter buttons (see the "Changing Parameter Values" section later in this chapter).

Note: You can configure the ventilator to automatically select Adult parameter defaults at start up from the start config sub-menu from the menu.

Warning! **Never use the CPAP and BL mode on a patient that is NOT spontaneously breathing and/or may stop spontaneous breathing. CPAP and BL are intended for ventilatory support, NOT ventilation.**



When noninvasive CPAP and BL with LC is used, the head with mask icon appears in the location used by the speaker/mute icons. Low and Medium priority alarms cause this head with mask icon to disappear. It reappears when low priority alarms are muted.



When Medium priority alarms are muted, the muted speaker icon appears.

8. Change Operating Mode (Optional)

The ventilator offers four operating modes that you can use to manage the patient (active modes, AC and SIMV can provide either pressure or targeted ventilation): See, "Chapter 4 Using the Ventilator" for detailed instructions.

- **AC** (Assist/Control) -- The patient receives either controlled or assisted breaths. When the patient triggers an assisted breath, the patient receives a breath based on either the volume or pressure target.
- **SIMV** (Synchronized Intermittent Mandatory Ventilation)-- The patient receives controlled breaths based on the set breathing rate. Spontaneous breaths are either unsupported demand flow or supported using Pressure Support.

Note: SIMV mode is an optional mode and might not be available on your ventilator.

- **CPAP** (Continuous Positive Airway Pressure) -- The patient receives constant positive airway pressure while breathing spontaneously. Spontaneous breaths are either demand flow or supported using Pressure Support.
- **BL** (Bilevel) -- the ventilator provides two pressure settings to assist patients breathing spontaneously: a higher inspired pressure (IPAP) and a lower expiratory pressure (EPAP).

To select the operating mode, press the **Mode** parameter button, turn the **Dial** to highlight the mode you want to use, and press the **Accept** button.

See, "Appendix E Transitions" for more information on mode transitions.

When transitioning from active ventilation to CPAP/BL modes, or from CPAP/BL with LC mode to active ventilation, the following parameter/alarm limit may be adjusted:

- Low BPM alarm
- High BPM alarm
- Low Airway Pressure alarm
- PEEP
- VT High Limit
- VT Low Limit
- Rise Time
- Pressure Support

Warning! The transition into CPAP or BL automatically adjusts the rise time and always needs to be checked since the setting might need further adjustment. Before using the ventilator with an infant or small child, you should always configure the ventilator appropriately before attaching the patient and monitor the patient to ensure optimal support.

Note: The Patient Detect alarm triggers when you connect the patient to the ventilator while the Start Menu is still active. To resolve the alarm, you must select a mode of ventilation and configure the device appropriately for the patient. In addition, you should perform the Operational Test procedure before reconnecting the patient to the device.

9. Change Parameter Values

If the patient requires parameter values that differ from the default values, you can use the parameter buttons to change these values. To change the parameter values, press the parameter buttons to highlight the primary parameter and secondary parameter values, or press and hold the parameter button to display the parameter's context menu. Use the **Dial** to adjust the value of the highlighted parameter. Press the **Accept** button to implement the change.

Warning! The alarm limits must be appropriate for the patient being ventilated. If a parameter is changed, adjust the high and low alarm limit to bracket the new value.

10. Perform Operational Test

Before attaching the patient to the ventilator, you should perform an Operational Test to ensure that the breathing circuit is properly attached and that the primary patient safety alarms, such as PATIENT DISCONNECT and AIRWAY PRESSURE HIGH are functioning properly.

To perform the operational test procedure, do the following:

- a. Press the **Manual Breath** button; gas should flow out of the patient connection each time the button is pressed.
- b. Close the patient port with a clean gloved hand. The **High Airway Pressure Limit** alarm should activate after 2 breaths that reach the PIP High Limit.

If the Airway Pressure High alarm fails to activate, check to determine that all of the circuit connections are secure, the exhalation valve is closing during inhalation, and that the High Airway Pressure Limit is set to 35 cm H₂O (hPa) or less.

- c. After a breath or two, release the patient port while allowing the ventilator to operate. The Patient Disconnect alarm should activate.

- d. Partially close the patient port to reset the Patient Disconnect alarm.
- e. With no other alarms occurring, remove external power from the ventilator. The External Power Low/Disconnect alarms should activate. Reconnect external power to reset alarms.
If either the High Airway Pressure, Patient Disconnect, or External Power Low/Disconnect alarms fail to activate, continue to manually ventilate the patient, check the patient circuit for leaks or a faulty exhalation valve and repeat the operational test.

If operating using the internal battery, verify that the Battery icon indicates sufficient available battery capacity remains to support the anticipated duration of operation. If not, begin ventilation and find an alternate source of power.

Warning! Until you have determined that the ventilator is functioning properly and that the ventilator parameters are set correctly for the patient, do not connect the patient to the ventilator.

11. Attach the Pulse Oximeter (Optional)

The pulse oximeter operates in all ventilator modes when its cable and sensor are properly attached to the SpO₂ connector (during start up, the pulse oximeter is on standby -- the SpO₂ and HR parameter windows display *stby*).

To operate the pulse oximeter, connect the sensor to the patient and the cable to the SpO₂ connector on the top of the ventilator as shown in the Figure 3-7.

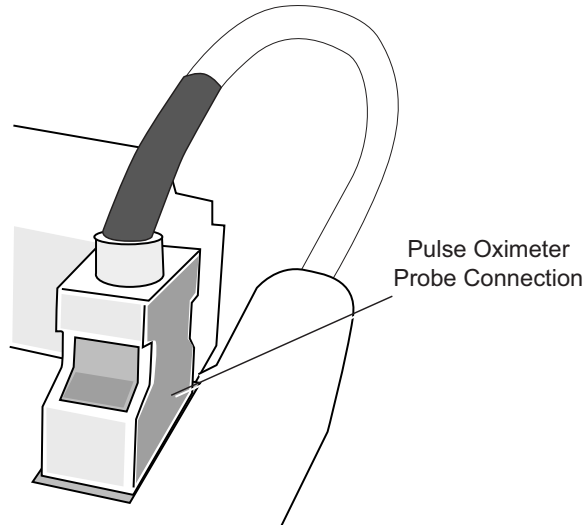

Figure 3-7 Connecting the Pulse Oximeter Sensor

Monitoring begins automatically when a valid patient signal is detected for greater than 10 seconds. For more information about the Masimo pulse oximetry technology that the ventilator uses, see Appendix C, Pulse Oximeter Principles.

12. Attach Patient

After you confirm that the ventilator is operating correctly, detach the test lung (if used in the Operational Test) from the patient circuit. Attach the patient airway (endotracheal tube, supraglottic airway or tracheotomy tubes) or mask to the patient circuit connection port.

Note: If there are circuit-related alarms during set up or initial use, such as Disconnect, PEEP Leak, Low Airway Pressure, or Auto PEEP, check all circuit connections and the exhalation valve.

Caution When patient conditions require a PEEP = 0, ensure the exhalation valve is in the upright position. The orientation of this valve position may impact the ability to deliver the intended tidal volume for small volumes or slow rise times.

Warning! Never leave the patient unattended.

Warning! Always ensure that there is an alternate means of providing mechanical ventilation. A bag-valve resuscitator and an appropriate mask for the patient being ventilated should be immediately available.

Warning! Do not connect the patient to the ventilator until you determine that the ventilator is functioning properly and that the ventilator parameters are set correctly for the patient.

Warning! Do not connect anything to the USB connection. The USB connection does not provide any signal output or input to the user. The USB connection is a tooled access used during service of the device.

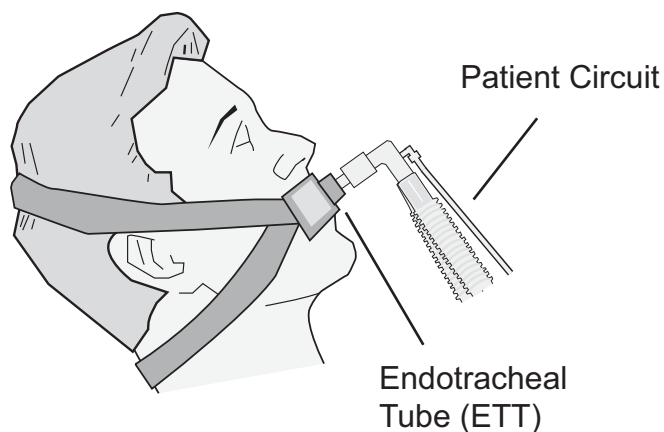

Figure 3-8 Attaching the Patient

Chapter 4

Using the Ventilator

This chapter describes how to use a ZOLL ventilator. Effective operation of the ventilator requires understanding of the following topics:

- Operating mode availability by ventilator model
- Initial operation with default (predefined) parameter settings
- Changing parameter settings
- Saving custom configurations for future use
- Using the last settings enabled on the ventilator
- Mode Parameter Window Options
- BPM Parameter Window Options
- Vt Parameter Window Options
- PIP Parameter Window Options
- FIO₂ Parameter Window Options
- SpO₂ Parameter Window Options
- HR Parameter Window Options
- Popup Messages
- Transitions
- Using the Menu

Operating Mode Availability

Mode availability is dependent on your ZOLL ventilator model. The table that follows provides information on mode availability for ZOLL ventilator models.

| Ventilator Model | Modes Supported | Leak Compensation | Target | Pressure Support | Regional Mode Reference*** |
|--|-----------------|-------------------|----------|------------------|----------------------------|
| Z Vent Basic | AC(V) | Not Available | Volume | No | VC-CMV |
| | AC(P) | Not Available | Pressure | No | PC-CMV |
| | CPAP* | On (Default)** | Pressure | Yes | PC-CSV |
| | BL* | On (Default)** | Pressure | Yes | PC-CSV |
| Z Vent Z Vent MR | AC(V) | Off (Default) | Volume | No | VC-CMV |
| | AC(P) | Off (Default) | Pressure | No | PC-CMV |
| | SIMV (V) | Off (Default) | Volume | Yes | VC-IMV |
| | SIMV (P) | Off (Default) | Pressure | Yes | PC-IMV |
| | CPAP* | On (Default)** | Pressure | Yes | PC-CSV |
| | BL* | On (Default)** | Pressure | Yes | PC-CSV |
| EMV+ EMV+ MR | AC(V) | Off (Default) | Volume | No | VC-CMV |
| | AC(P) | Off (Default) | Pressure | No | PC-CMV |
| | SIMV (V) | Off (Default) | Volume | Yes | VC-IMV |
| | SIMV (P) | Off (Default) | Pressure | Yes | PC-IMV |
| | CPAP* | On (Default)** | Pressure | Yes | PC-CSV |
| | BL* | On (Default)** | Pressure | Yes | PC-CSV |
| Eagle II Eagle II MR | AC(V) | Off (Default) | Volume | No | VC-CMV |
| | AC(P) | Off (Default) | Pressure | No | PC-CMV |
| | SIMV (V) | Off (Default) | Volume | Yes | VC-IMV |
| | SIMV (P) | Off (Default) | Pressure | Yes | PC-IMV |
| | CPAP* | On (Default)** | Pressure | Yes | PC-CSV |
| | BL* | On(Default)** | Pressure | Yes | PC-CSV |
| AEV | AC(V) | Not Available | Volume | No | VC-CMV |
| | AC(P) | Not Available | Pressure | No | PC-CMV |
| | CPAP* | On (Default)** | Pressure | Yes | PC-CSV |
| | BL* | On (Default)** | Pressure | Yes | PC-CSV |
| * Spontaneously Breathing Patient Mode | | | | | |
| ** When Mask CPAP selected from Startup Menu | | | | | |
| *** Outside of the United States | | | | | |

Initial Operation with Default Parameter Settings

After turning on the ventilator, the ventilator goes through a Self-Check (a set of system tests and checks). If the Self-Check passes, the LED array turns green and the Start Menu displays, indicating that the ventilator is operational.

The Start Menu enables the user to choose between predefined ventilator parameter settings (for adult patients, pediatric patients, patients requiring Mask CPAP), a previously saved set of Custom parameter settings, or the parameter settings last used during ventilator operation. The Start Menu choices include:

| Choice | Description |
|---------------|--|
| Adult | Preset ventilation parameter settings for adult patients. |
| Pediatric | Preset ventilation parameter settings for pediatric patients. |
| Mask CPAP | Preset ventilation parameter settings for Mask CPAP (Continuous Positive Airway Pressure) ventilation. |
| Custom | Ventilation parameter settings previously saved by a user. |
| Last Settings | The settings enabled on the ventilator during its last use (but not saved as Custom Settings by the user). |

Warning! Do not connect patient to the ventilator while the Start Menu is active.

Default Parameter Settings for Adult, Pediatric and Mask CPAP

Default parameter settings might be localized to meet country-specific specifications. The standard factory default settings for Adult, Pediatric, and Mask CPAP are as follows:

Adult Default Parameter Setting Values

| Parameter | Default Setting Value |
|------------------|-----------------------|
| Mode | AC (V) |
| BPM | 12 |
| I:E | 1:3 |
| VT | 450 |
| PEEP | 5 |
| PIP Limit | 35 |
| FIO ₂ | 21 |

Pediatric Default Parameter Setting Values

| Parameter | Default Setting Values | |
|---|------------------------|-------|
| Mode | SIMV (P)* | AC(P) |
| BPM | 20 | 20 |
| Ti | 0.6 | 0.6 |
| PIP | 20 | 20 |
| PEEP | 4 | 4 |
| PIP Limit | 30 | 30 |
| FIO ₂ | 21 | 21 |
| * SIMV (V) and SIMV (P) modes are not available on all ventilator models. See "Operating Mode Support" in Chapter 2 for more information. | | |

Mask CPAP Default Parameter Setting Values

| Parameter | Default Setting Value |
|------------------|-----------------------|
| Mode | CPAP |
| Backup BPM | 12 |
| Backup I:E | 1:3 |
| Backup PIP | 20 |
| PEEP | 5 |
| PIP Limit | 30 |
| FIO ₂ | 21 |

Making a Choice From the Start Menu

Choose the option that is most appropriate for the patient. With the Start Menu displayed, follow these steps:

1. Turn the **Dial** to highlight your choice. For example, to choose the Mask CPAP default, turn the **Dial** until Mask CPAP highlights.
2. Press the **Accept** button to enable your choice. The ventilator begins operation with the choice you made. For initial set-up, see Chapter 3.

Note: The ventilator provides a 120-second alarm mute it automatically clears as described above to allow the provider time to adjust parameter settings for the patient.

Changing Parameter Settings

The ventilator helps you to manage the patient by organizing ventilator parameters in groups that are accessed through *parameter windows* on the right side of the display screen. A button corresponding to each window, enables you to select and set parameters.

| Parameter Group Item | Description |
|--|---|
| Primary Parameter | The primary parameter setting accessed and controlled through the parameter window. These are labeled with large font as: HR, SPO ₂ , FIO ₂ , PIP, Vt, BPM, and Mode. |
| Secondary Parameters and Alarm Thresholds/Limits | Secondary parameters associated with the primary parameter and alarm thresholds for alarms associated with the primary parameter, (small font). |
| Context Menu | Additional settings that further adjust the performance of the device related to the primary parameter. |

Parameters controlled by the user appear as solid text (or a solid symbol) in either the parameter window or auxiliary boxes. Parameters dependent on the patient appear as outlined text in the parameter window. Figure 4-1 shows parameter windows.

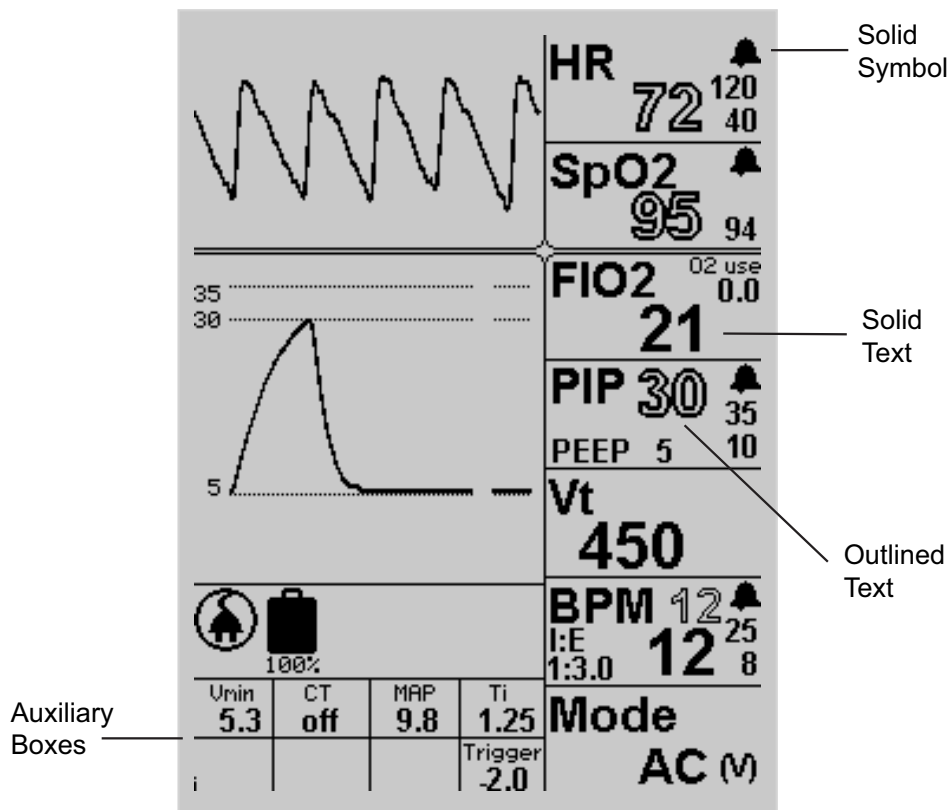

Figure 4-1 Parameter Windows and Auxiliary Boxes

Figure 4-2 shows the buttons associated with parameter windows.

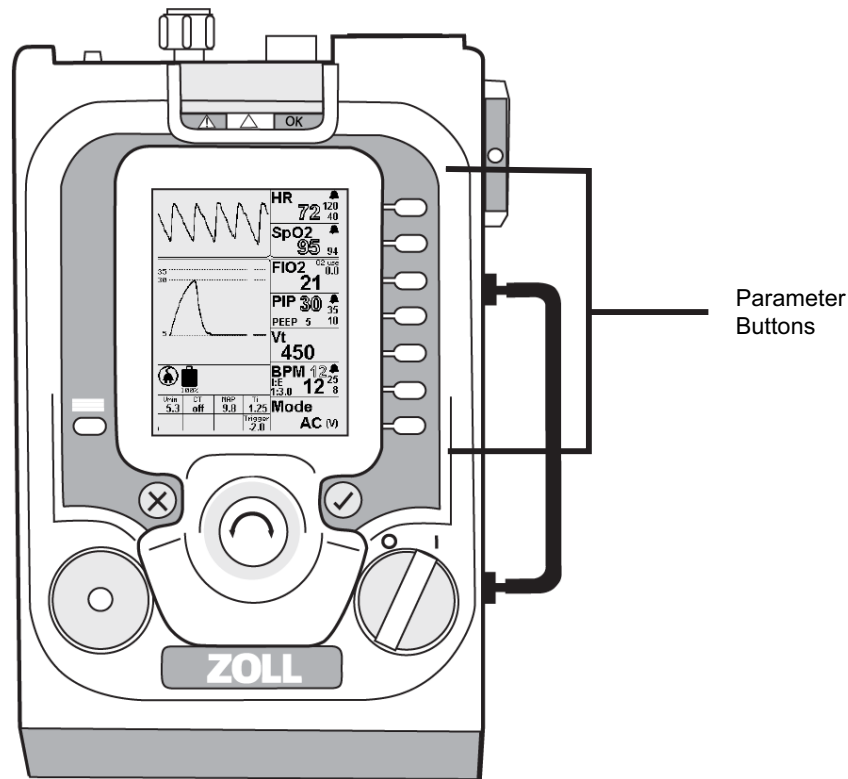

Figure 4-2 Parameter Buttons

Navigating the Parameter Windows Using Parameter Buttons

Parameter values are accessed with a parameter button as follows:

- **Single Press:** highlights the primary parameter for the chosen parameter window
- **Multiple Presses:** highlights secondary parameters and alarm limits. (Multiple presses highlight secondary parameters moving in a clockwise direction)
- **Press and Hold:** opens the context menu (for those primary parameters that have a context menu). Turning the **Dial** highlights context menu items.

Note: If you attempt to set parameter values that are outside the typical clinical range of settings, the ventilator displays popup messages that ask if you are sure you would like to set the parameter to that value. We describe popup messages in more detail later in this chapter. To set the parameter above the limit, you must press the **Accept** button, and then adjust the values and press the **Accept** button again.

Changing a Parameter Setting

To change a parameter, follow these steps.

1. Access the parameter you intend to change using the parameter buttons as described in the previous sections.
2. Press the **Accept** button to highlight your choice. Multiple presses are required for secondary parameters.
3. Turn the **Dial** to adjust the parameter value
4. Press the **Accept** button to enable your choice.

The examples that follow describe how to change a primary parameter, secondary parameter, and a context menu parameter.

Example 1 — Changing a Primary Parameter

In Example 1, the ventilator is operating with the default Adult parameters. The user wants to change the Mode from AC (Adult Default) to CPAP.

To change the Mode parameter from AC to CPAP, follow these steps:

1. Press the **Mode** parameter button once.
2. Turn the **Dial** until the Mode parameter window displays CPAP.
3. Press the **Accept** button.

See, “Appendix E Transitions” for more information on mode transitions.

Example 2 — Changing a Secondary Parameter

In Example 2, the ventilator is operating with the default Adult parameters and user wants to adjust the PEEP secondary parameter setting from 5 (the adult default setting) to 7 cm H₂O (hPa).

To change the secondary parameter PEEP setting from 5 to 7, follow these steps:

1. Press the **PIP** parameter button until PEEP is highlighted.
2. Turn the **Dial** until the PEEP setting is 7 as displayed in the PIP parameter window.
3. Press the **Accept** button.

Example 3— Changing a Context Menu Parameter

In Example 3, the ventilator is operating with the default Adult parameters and user wants to change the Masimo Pulse Oximeter Sensitivity from Norm (normal) which is the adult default setting – to Max (maximum).

To change the Sensitivity setting from *Norm* to *Max*, follow these steps:

1. Press and hold the **HR** or **SpO₂** parameter button until the Masimo context menu displays.
2. Release the parameter button, then turn the **Dial** until the Sensitivity choice highlights, then press the **Accept** button. The Sensitivity setting highlights.
3. Turn the **Dial** until the setting changes to Max (maximum).
4. Press the **Accept** button.

Saving Changed Parameters for Future Use

When you change parameters, you can save them for future use through the Custom Settings Menu option.

To save changed parameters for future use, follow these steps.

1. With the ventilator turned on, make the desired parameter changes using the parameter buttons, Dial and Accept button.
2. Press **Menu** button.
3. Using the **Dial**, highlight Powerup Settings, and then press the **Accept** button.
4. Use **Dial** to highlight Custom Settings, then press the **Accept** button to highlight Save, and then press the **Accept** button again to save the changed parameters.

To use or confirm that the changed parameters are saved as Custom settings, follow these steps:

1. Turn on the ventilator.
2. When the Start up Menu displays, turn the **Dial** to highlight Custom Settings, and then press the **Accept** button.
3. The ventilator displays the custom parameter settings in the parameter windows.

Warning! **The Custom and Last Setting options save the current configuration of the ventilator. Always ensure that the both the ventilation settings and alarm limits are appropriate for the patient.**

Using the Last Settings Enabled on the Ventilator

The ventilator preserves the last setting used on the ventilator (even if they were not saved as Custom Setting). To use the last settings, do the following:

1. Turn ON the ventilator, wait for the Self-Check to complete, and the Start Menu to display.
2. Turn the **Dial** to highlight the Last Settings choice.
3. Press the **Accept** button to enable your choice.

The ventilator begins operation with the last settings used.

Warning! **Last Settings uses all of the parameters including alarms. You must ensure that both the setting and alarms are appropriate for the patient.**

Mode Parameter Window Options

The ventilator allows you to select different ventilation modes to optimally manage the patient.

Primary Parameter

The Mode parameter window has four primary parameter choices.

- **AC (Assist/Control)** -- The patient receives either controlled or assisted breaths. When the patient triggers an assisted breath, they receive a breath based on either the volume or pressure target.
- **SIMV (Synchronized Intermittent Mandatory Ventilation)** -- The patient receives controlled breaths based on the set breathing rate. Spontaneous breaths are either unsupported demand flow or supported using Pressure Support.

Note: SIMV mode is an optional mode and might not be available on your ventilator.

- **CPAP (Continuous Positive Airway Pressure)** -- The patient receives constant positive airway pressure while breathing spontaneously. Spontaneous breaths are either demand flow or supported using Pressure Support.
- **BL (Bilevel)** -- the ventilator provides two pressure settings to assist patients breathing spontaneously: a higher inspiratory pressure (IPAP) and a lower expiratory pressure (EPAP).

Secondary Parameters and Alarm Thresholds/Limits

The Mode parameter window has two secondary parameter choices.

- Breath target
- Leak Compensation

Breath Target

- **Volume targeting (V)** -- assures a constant volume is delivered to the patient in the inspiratory time using a constant flow. During volume targeting, the PIP parameter appears as outlined text.
- **Pressure targeting (P)** -- provides a constant airway pressure for the duration of the inspiratory time using a decelerating flow pattern. During pressure targeting, the Vt parameter appears as outlined text.

To set (or change) the Breath Target, follow these steps:

1. Press the Mode parameter button twice to highlight the Breath Target parameter
2. Use the **Dial** to switch between V (Volume Targeting) and P (Pressure Targeting)
3. Press the **Accept** button.

See, “Appendix E Transitions” for more information on mode transitions.

Note: Please note that tidal volume cannot be adjusted in pressure-targeted ventilation. You may have to adjust PIP to maintain desired tidal volume.

To adjust the PIP target in Pressure Targeted ventilation, follow these steps:

1. Press the **PIP** parameter button.
2. Use the **Dial** to set the desired PIP target value.
3. Press the **Accept** button.

In pressure target ventilation, setting the high and low tidal volume limits protect against leaks and ensures delivery of a minimum tidal volume.

Warning! During pressure-targeted ventilation, always set the high tidal volume just above the patient's maximum tidal volume. In the event of disconnection or decannulation, the increase in volume will trigger the alarm.

Leak Compensation

Leak Compensation (LC) is available in all pressure-targeted ventilation modes for full-featured ventilators or limited to start up settings (see Operating Modes Availability table above). Leak compensation provides flow during the expiratory phase to maintain the baseline pressure caused by a leaking airway or facemask. Leak compensation can accommodate expiratory leaks from 0 to 30 liters per minute.

To activate leak compensation, follow these steps:

1. Press the Mode parameter button twice. The “No Leak Compensation” icon highlights.
2. Turn the **Dial** to turn leak compensation ON. A pop-up message appears asking for confirmation.
3. Press the **Accept** button to activate Leak Compensation.

To avoid nuisance alarms in patients with active leaks, Leak Compensation suppresses the following alarms:

- Low Airway Pressure (SC: 2071)
- High Tidal Volume (SC: 2072)
- Low Tidal Volume (SC: 2073)

Note: Once the patient is stable on CPAP or BL, the suppressed alarms should be set to ensure safe ventilation of the patient. When in BL or CPAP modes, the Insufficient Flow alarm (SC: 2095) triggers when the patient's inspiratory flow is greater than 100 lpm for two concurrent breaths. The operator may choose to decrease the magnitude of the breath trigger pressure (from default setting of -2 to -1 or -.05 cm H₂O) and decrease the Rise Time so that the flow reaches the maximum in a way that meets the patient's inspiratory demand.

Context Menu

The Apnea Backup context menu is accessible when the primary parameter is set to CPAP or BL modes.

Pressing and holding the Mode parameter button in CPAP or BL Modes displays the menu. The menu displays:

- PIP Target
- BPM
- I:E

Apnea Backup default settings are PIP target of 20, BPM 12, I:E (1:3), these settings should be adjusted for the patient you are supporting in CPAP or BL modes.

When Apnea ventilation is enabled, the ventilator provides pressure targeted breaths at the default Apnea settings or the provider can chose to change the settings. Apnea Backup is triggered using the BPM Low Limit setting.

If the low breath limit is set to 4 and a breath is not detected every 15 seconds the ventilator will begin ventilating at the Apnea Backup settings and trigger an alarm. In CPAP or BL modes, Apnea Backup is automatic.

To adjust or change any Apnea Backup settings,

1. From the menu, use the **Dial** to highlight the parameter to change, and then press the **Accept** button (The current highlighted parameter value highlights).
2. Use the **Dial** to set the desired value
3. Press **Accept** to enable the change.

Mode Parameter Window Reference

The following table provides a reference to the primary parameters, secondary parameters, and context menu parameters and other options for the Mode parameter window.

| Mode Parameter Window | | Options/Range | Availability/Notes |
|--|---------------------------|----------------------------|---|
| Primary Parameter | Mode | AC | |
| | | SIMV | Optional mode* |
| | | CPAP | |
| | | BL | |
| Secondary Parameters | Breath Target | (V) or (P) | |
| | LC (Leak Compensation) | ON or OFF (Default OFF) | AC (P) and SIMV(P) modes |
| | | OFF | BL Mode |
| | Default ON | CPAP Mode | |
| Alarms | None | | |
| Measured Value | None | | |
| Mode Context Menu | | | Context menu is available in CPAP and BL Modes |
| Apnea Backup | BPM | 1 to 80 | |
| | PIP | 10 to 80 | |
| | I:E, Ti | 1:99, 0.1 to 3 | Control selected in context BPM context menu |
| * SIMV mode is an optional mode and might not be available on your ventilator. | | | |

Warning! Apnea Backup settings are appropriate for most adult patients. For small adult and pediatric patients, adjust the Apnea Backup settings so that they are appropriate for the patient.

BPM Parameter Window Options

The BPM (Breathes Per Minute) parameter window defines the number of breaths per minute delivered by the ventilator, as well as other parameters related to breath timing.

For AC and SIMV ventilation modes, the BPM parameter displays the setting as solid text. The BPM parameter range is 0 to 80.

The BPM measured range is from 0 to 99.9

When CPAP and BL mode are used the primary parameter is the patient's breathing rate, shown in the outlined text.

Assisted and controlled breaths are time-triggered and time-cycled. Spontaneous breathes are patient triggered and flow cycled.

Secondary Parameters and Alarm Thresholds/Limits

The secondary parameters for the BPM parameter window are the following:

- BPM High Limit (number immediately below the Alarm Bell symbol)
- BPM Low Limit (lower number below the Alarm Bell symbol)
- Control Parameter (I:E ratio or Ti)

Note: Display of I:E or Ti in the BPM parameter window is determined by the Control Parameter setting in the BPM context menu

The BPM High Limit can be set from 20 to 99 or to OFF.

The BPM Low Limit can be set from 2 to 40.

To change the BPM High Limit or BPM Low Limit secondary parameter setting, follow these steps:

1. Press the BPM parameter button until the BPM High Limit or BPM Low Limit secondary parameter highlights..
2. Turn the **Dial** to the desired limit setting.
3. Press the **Accept** button.

To change the Control parameter setting, follow these steps:

1. Press the BPM parameter button until the I:E or Ti secondary parameter highlights.
2. Turn the **Dial** to change the setting (either I:E or Ti).
3. Press the **Accept** button.

Context Menu

Pressing and holding the BPM parameter button brings up the BPM context menu. Different parameters associated with the BPM can be adjusted in this context menu. The menu offers the option of changing the following:

- Control Parameter (I:E or Ti)
- Rise Time (when pressure targeted breathes are available)
- Cycle Off %
- Spont Ti Limit

Control Parameter (I:E or Ti)

The control parameter allows you to select between I:E ratio and Ti. The control parameter you select is displayed in the parameter window and the parameter you are measuring is always calculated and shown in the auxiliary boxes.

For AC and SIMV ventilation modes, control breaths are time-triggered and time-cycled. The ventilator uses the inspiratory time (Ti) parameter setting to terminate the breath being delivered.

For volume targeted breaths, the Ti parameter is used to determine the constant flow rate of the delivered breath. Popup messages are triggered to alert the user if inappropriate settings are selected.

The default inspiratory/expiratory control parameter is I:E ratio unless the pediatric default is selected. The ventilator automatically calculates the inspiratory time, and displays it when the I:E ratio is controlled, and it calculates the I:E ratio when the inspiratory time is used. Both are always displayed on the screen.

I:E Ratio may be adjusted so that inspiration time is longer than expiration time (referred to as inverse I:E with a range from 4.0:1 to 1.0:1, whereas normal I:E is from 1:1.0 to 1:99). Going inverse requires a popup confirmation due to the potential for harm when this setting is inappropriate for the patient's condition.

Inverse I:E ratio is not available on all devices.

Rise Time

Rise Time allows the user to adjust the time it takes to reach the full inspiratory flow and Peak Inspiratory Pressure (PIP) during pressure targeted breathing. The Rise Time displays in the auxiliary boxes at the bottom of the display (See Figure 4-1). Use the PIP waveform as a reference when adjusting the Rise Time for the patient. Rise time is available in these ventilation modes:

- AC (P)
- SIMV (V or P)
- CPAP
- BL

When Pressure Support is enabled, you can adjust the time it takes to reach the PIP, where 1 is the shortest and 10 is the longest. You should reassess and readjust the Rise Time settings after the patient is placed on the ventilator and initially stabilized. To minimize patient's work of breathing and potential for pressure overshoots, the following should be considered when setting the Rise Time:

- Patient tidal volume
- Patient respiratory pattern
- Patient's comfort
- Patient's flow demand
- Patient's lung mechanics - resistance and compliance

Rise Time for a passive lung is driven primarily by airway resistance, and is fairly independent of compliance.

Increasing Rise Time also decreases the maximum flow from the ventilator to allow for the management of infant and pediatric patients.

Note: An adult patient with high resistance may benefit from a Rise Time setting of 3 to 4 for optimal breath delivery. Rise Times of 8 to 10 are optimized for infants and are flow limited. (The infant circuit is not intended for flows > 60 LPM.)

Cycle Off % Parameter

For flow cycled breaths, the ventilator transitions from inspiratory to expiratory phase when the flow drops below a set percentage of the peak flow. The default is 25% of peak flow with a range of 10 to 70% Cycle Off % is typically used during noninvasive ventilation to ensure the breath cycles in synchrony with the patient. Some patients may have difficulty cycling due to their lung mechanics or a bag that prevents the flow from reaching the cycle flow rate. When this happens, spontaneous breathe may time cycle causing asynchrony.

You can adjust the Cycle Off% value to account for patient leaks and weak respiratory effort.

Users must carefully assess the patient's response when adjusting the Cycle Off % to avoid cycle asynchrony and patient discomfort

Note: The longest duration of a spontaneous breath is 5 seconds. At the end of this time, the ventilator ends flow and opens the exhalation valve.

If there is no leak, increasing the Cycle Off % parameter causes breaths to cycle sooner, and deliver less volume. If you set the Cycle Off % parameter too high, the breath ends early relative to patient effort, which may lead to the triggering of a second breath.

Spont Ti Limit Parameter

The Spontaneous Inspiration Time (Spont Ti) Limit parameter provides an additional method to limit the duration of spontaneous breaths in the presence of a leak or weak respiratory effort. The parameter provides an inspiratory time limit for spontaneous breaths.

Adult default is 3.00 sec, Pediatric default is 2.00 sec, and Mask CPAP default is 3.00 sec.

BPM Parameter Window Reference

The following table provides the options and ranges for the BPM parameters:

| BPM Parameter Window | | Options/Range | Availability/Notes |
|---------------------------|--|--|--|
| Primary Parameter | BPM Breaths per minute | 1 to 80 | |
| Secondary Parameters | Ti (sec) or I:E | Ti 0.1 to 3.0 or I:E 1:1 to 1:99 | |
| | | Ti 0.1 to 5.0 or I:E 4:1 to 1:99 | |
| Alarm Limits | BPM High | 20 to 99, OFF | |
| | BPM Low | 2 to 99 | |
| Measured Value | l/min | 0 to 99 | |
| BPM Context Menu | | | |
| Control Parameter | Default I:E | I:E or Ti (sec) | The control value is shown in the parameter window, the dependent value is shown in the Auxiliary Box. |
| Rise Time - | Pediatric Default 5 Mask CPAP Default 3 | 1 to 10 | Auxiliary Box |
| Cycle Off % (% Cycle) | Default 25% | 10 to 70% | Auxiliary Box |
| Spont Ti Limit | Default Adult = 3.00 Infant = 2.00 Mask CPAP = 3.00 | 0.30 to 4.00 | |

Vt Parameter Window Options

The Vt parameter defines the volume (ml) delivered to the lung with each breath. Tidal volume is calculated by integrating the flow over the inspiratory time. During volume targeted breathing, pressing the Vt parameter button highlights the currently set tidal volume and enables it to be changed. When breathing is pressure targeted, the delivered tidal volume is shown as outlined text and is based on the PIP and patient's pulmonary mechanics.

Warning! In CPAP and BL, a Vt that is lower than anticipated may be an indication that the patient is not able to adequately ventilate. The minimum tidal volume during volume-targeted ventilation is 50 ml.

Note: In CPAP, the Vt delivered and V_{min} may be overestimates of the true volume going to the patient when leaks are present. The O₂ Use values accurately display the O₂ use, though the amount used is more than if no leak was present.

Warning! If significant leaks are present during CPAP and BL modes, the Vt delivered and V_{min} shown may be overestimates of what is actually being delivered to the patient. The adequacy of ventilation should be assessed using an alternate method.

Secondary Parameters and Alarm Thresholds/Limits

The secondary parameters for the Vt parameter window are the following:

- Vt High Limit (lower number below the alarm bell)
- Vt Low Limit (number below the Vt High Limit)

Note: The Vt High Limit and Vt Low Limit are not presented during volume targeted ventilation because the ventilator automatically alarms if two consecutive breathes are out of range.

The Vt High Limit can be set from 50 to 2000 (ml). The Vt Low Limit can be set to OFF, or it can be set from 5 to 500 (ml).

The Vt High Limit parameter cannot be adjusted below the primary parameter Vt setting or the Vt Low Limit setting and attempting to do so generates a conflict popup message.

The Vt High Limit parameter is used to limit the delivered tidal volume during pressure targeted breaths. If two consecutive breaths are limited by the setting of this parameter, the High Tidal Volume alarm (SC: 2072) is triggered. The Vt Low Limit parameter setting is used to trigger the Low Tidal Volume alarm (SC: 2073).

Warning! During pressure targeted breathing with infant and pediatric patients, always set the high tidal volume limit just above the desired tidal volume. Doing this ensures an alarm in the event of a leak or decanulation.

To change a limit setting, follow these steps:

1. Press the Vt parameter button more than once until the desired Vt limit setting highlights.
2. Turn the **Dial** until the desired value is reached.
3. Press the **Accept** button to enable the change.

Context Menu

Pressing and holding the Vt parameter button brings up the Vt context menu that includes:

- Compliance
- Adult
- Infant
- Compliance Volume

The tubing compliance can be set to off, adult, or infant.

Users can choose to use the adult or infant circuit defaults for the standard ZOLL adult/pediatric and infant/pediatric patient circuits. Compliance for reusable circuit should be adjusted according to circuit labeling.

The patient circuit is part of the breathing system of the ventilator. Tubing compliance of the circuit is a physical property that affects the tidal volume delivered to the patient. The ventilator allows you to adjust the compliance value of the circuit (see Chapter 6 for more information).

Tubing compliance is adjustable and a different compliance value can be entered for each circuit type by selecting either of the menu items. The range is limited for the adult patient circuits from 0 to 3.5 ml/cm H₂O and from 0 to 2 ml/cm H₂O for the infant circuits to prevent a selection beyond the range of the standard circuits.

In order to prevent inappropriate or unsafe use of this feature, the tubing compliance compensation is turned OFF at startup.

Adult and Infant settings correspond to the standard WYE patient circuit used. Adult CT range is between 0 and 3.50 ml/cm H₂O (default of 1.60 ml/cm H₂O), and the Infant CT range is between 0 and 2.00 ml/cm H₂O (default of .5 ml/cm H₂O).

During volume targeted breathes the ventilator corrects for the loss due to C_T by adding the correction to the set Vt ensuring that the set volume is delivered to the patient. During pressure targeted breaths the compensation volume is subtracted from the displayed Vt to indicate the volume delivered to the patient.

To change a Vt context menu setting, follow these steps:

1. Press and hold the Vt parameter button until the Vt context menu displays.
2. Release the Vt parameter button, then turn the **Dial** until the context menu item you want to change highlights, then press the **Accept** button. The current setting for the context menu parameter highlights.
3. Turn the **Dial** to change the value of the parameter.
4. Press the **Accept** button.

Vt Parameter Window Reference

The following table provides the options and ranges for the Vt window parameters:

| Vt Parameter Window | | Options/Range | Availability/Notes |
|-------------------------------------|------------------|--------------------|--|
| Primary Parameter | Vt ml | 50 to 2000 | Volume Target: Control Setting Pressure Target: Measured |
| Secondary Parameters | None | | |
| Alarm Limits | High Vt | 50 to 2000, Off | Limits are not present during volume targeted ventilation |
| | Low Vt | 5 to 500, Off | |
| Vt Context Menu | | | |
| Tubing Compliance (C _T) | Default: Off | OFF, Adult, Infant | Auxiliary Box |
| Adult | Default: 1.60 | 0 to 3.50 | User entered values are not retained when the ventilator is turned OFF |
| Infant | Default: 0.50 | 0 to 2.00 | |
| Compliance Volume (ml) | (Measured value) | 0 to 349 | |

PIP Parameter Window Options

The PIP (Peak Inspiratory Pressure) parameter window displays and/or controls airway pressure. The breath target determines if the PIP value is a measurement or a control setting (solid text). When PIP is a control setting, the user can adjust PIP from 10 to 80 cm H₂O.

Note: When the user attempts to set a PIP value greater than 60 cm H₂O (hPa), a popup message displays prompting for a confirmation before values above 60 cm H₂O (hPa) are available.

During **pressure targeted** ventilation, the PIP parameter is displayed as solid text.

During **volume targeted** ventilation, the PIP primary parameter is a measurement and displays as outlined text.

Positive End Expiratory Pressure (PEEP) is the baseline pressure maintained above atmospheric pressure at the end of exhalation to prevent alveolar collapse and improve gas exchange.

For **BL mode**, the ventilator provides noninvasive ventilation with the ability to manage the patient by adjusting the IPAP and EPAP parameters. IPAP is adjustable from 6 to 60 cm H₂O (hPa), EPAP is adjustable from 3 to 30 cm H₂O (hPa).

Secondary Parameters and Alarm Thresholds/Limits

In **pressure targeted** ventilation mode, the following secondary parameters are available.

- PIP High Limit
- PIP Low Limit
- PEEP
- PS (Available for SIMV(P), CPAP, and BL)

For the PIP High Limit and PIP Low Limit, the user can set the PIP High Limit from 20 to 100 cm H₂O (hPa). For the PIP Low Limit from 3 to 35 cm H₂O (hPa), or turn the PIP Low Limit to OFF.

Note: PEEP cannot be set within 5 cm H₂O (hPa) of the PIP High Limit setting.

Warning! **Set the PIP Low Limit to be at least PEEP +5. This reduces the likelihood of not detecting a kinked hose. Setting the PIP Low Limit just below the PIP can also serve to detect leaks and patient circuit as a PIP compensated disconnected threshold.**

To change an a PIP secondary parameter, follow these steps:

1. Press the PIP parameter button more than once until desired alarm threshold highlights in the PIP parameter window.
2. Turn the **Dial** to set a parameter value.
3. Press the **Accept** button.

Context Menu

The PIP context menu provides the user the ability to adjust the pressure needed to trigger a breath minimizing the work of breathing and prevent auto-triggering in the presence of leaks and very high motion environment.

When ventilating infants and other patients with weak inspiratory effort, the trigger threshold may need to be adjusted. To reduce the work required for the patient to trigger a breath, decrease the magnitude.

To prevent auto-triggering, the magnitude of the trigger pressure may need to be increased. (This should be done with caution as it will increase the work of breathing and may lead to asynchrony.)

The Spontaneous/Assisted Breath Trigger is preset to -2.0 cm H₂O (hPa) and can be adjusted from -6.0 to -0.5 cm H₂O (hPa) below the baseline (PEEP) pressure. To initiate a spontaneous or assisted breath, the patient must generate -2.0 cm H₂O (hPa). When the pressure drop is detected, an assisted breath is delivered. The trigger automatically adjusts when the PEEP is changed. The set Trigger Level threshold displays on the bottom of the screen.

Warning! **Set the trigger level so as to minimize the patient's inspiratory effort and prevent autotriggering. When ventilating infants and other patients with weak inspiratory effort, lower the trigger threshold magnitude (> -2 cm H₂O (hPa)) to reduce the work required for the patient to trigger a breath. If a large leak is present while ventilating in CPAP or BL with LC turned on, the trigger threshold magnitude may need to be increased to prevent auto-triggering with the variable baseline pressure.**

Airway pressure measurements are also displayed. The Airway Pressure waveform (0 to 100 cm H₂O (hPa)) is plotted over time with indications of the PEEP and PIP high limit. See Figure 4-1. The Mean Airway Pressure (MAP) measurement (0 to 99.9 cm H₂O (hPa)) is provided in the auxiliary box area of the ventilator display.

To change a the Trigger Level in the PIP context menu, follow these steps:

1. Press and hold the PIP parameter button until the PIP context menu displays.
2. Release the PIP parameter button, then turn the **Dial** until the Trigger Level highlights, then press the **Accept** button. The current setting for the context menu parameter highlights.
3. Turn the **Dial** to adjust the value of the parameter.
4. Press the **Accept** button.

Note: The scale of the Airway Pressure waveform varies based on the PIP High Limit. If the waveform is too small the PIP High limit maybe set too high.

PIP Parameter Window Reference

The following table provides the options and ranges for the PIP parameter window.

| PIP Parameter Window | | Options/Range | Availability/Notes |
|--|----------------------|-----------------------------|---|
| Primary Parameter | PIP | 10 to 80 | Volume Target: Measurement Pressure Target: Control Setting PIP values greater than 60 cm H ₂ O (hPa) require the user to perform a separate confirmation. |
| Secondary Parameters | PEEP | 0 to 30 | AC and SIMV* |
| | | 3 to 30 | CPAP |
| | PS | 0 to 60 cm H ₂ O | Spontaneous Breaths (SIMV* and CPAP) |
| | EPAP | 3 to 30 | BL |
| | IPAP | 6 to 60 | |
| Alarm Limits | High PIP | 20 to 100 | PEEP cannot be within 5 cm H ₂ O (hPa) of the PIP High Limit setting. |
| | Low PIP | 3 to 35, Off | |
| Measured Value | Mean Airway Pressure | 0 to 40 | |
| | MAP | | |
| | Paw Waveform | 0 to 99 | |
| PIP Context Menu | | | |
| Breath Trigger (Assisted, Spontaneous) | Default: -2 | -6 to -0.5 | Adjustment Increments:0.5 |
| * SIMV mode is an optional mode and might not be available on your ventilator. | | | |

FIO₂ Parameter Window Options

The FIO₂ (Fraction of Inspired Oxygen) parameter window manages oxygen delivery. Pressing the FIO₂ parameter button highlights the current FIO₂ value so that you can adjust it using the Dial. The default value at start up is 21% whether oxygen is present or not.

If an FIO₂ value greater than 21% is saved as a custom default or the last setting, the ventilator begins with that saved FIO₂ value if high-pressure oxygen is present. If high-pressure oxygen is not present, the ventilator begins operation with FIO₂ = 21% and the Low O₂ Supply Fault alarm is not activated to prevent a nuisance alarm.

The secondary display in the parameter window is O₂ Use¹. This value indicates the flow of high pressure oxygen (l/min) consumed with the current FIO₂ setting to support the patient (from 0 to 99.9 l/minute). This value can be used to calculate the time of useful O₂ flow from an O₂ cylinder: Flow time (min) = cylinder volume (l) / O₂ flow (l/min). O₂ Reservoir use is indicated on the display with a plus “+” sign next to the FIO₂ value. See Chapter 3 for more information.

Note: The “O₂ Use” parameter does not calculate low flow oxygen only high pressure oxygen use is calculated.

Secondary Parameters and Alarm Thresholds/Limits

There are no secondary parameters for the FIO₂ parameter window.

Context Menu

Access the FIO₂ context menu to turn the O₂ Reservoir ON or OFF.

Note: The O₂ reservoir feature ON can be used for following:

- When using the O₂ Reservoir for low flow oxygen
- In a high vibration environment
- When using biological or chemical filters.

When the O₂ reservoir feature is on 21+ displays in the FIO₂ parameter window indicating that O₂ is coming from a low-pressure external source. In addition, it also disables the Gas Intake Restricted alarm (SC: 3031) that can trigger due to the small resistance caused by the reservoir. This feature is used to eliminate nuisance alarms caused by the restriction of the external filter or extremely high vibration. To turn the O₂ Reservoir feature ON or OFF from the FIO₂ context menu, follow these steps:

1. Press and hold the FIO₂ parameter button until the FIO₂ context menu displays.
2. Release the FIO₂ parameter button, then turn the Dial until O₂ Reservoir highlights, then press the Accept button. The current setting for the O₂ Reservoir parameter highlights.
3. Turn the Dial to change the setting to ON or OFF.
4. Press the Accept button.

1. **O₂ Use = ((FIO₂-0.21)/0.79)*Minute Volume where FIO₂ is represented as a fraction and minute volume is the actual minute volume (controlled and spontaneous breaths * tidal volume).**

FIO₂ Parameter Window Reference

The following table lists the options and ranges for the FIO₂ parameter window:

| FIO ₂ Parameter Window | | Options/Range | Availability/Notes |
|-------------------------------------|----------------------------|---------------|--|
| Primary Parameter | FIO ₂ % | 21 to 100 | |
| Primary Parameter | FiO ₂ + | 21 | Demonstrates O ₂ reservoir mode is in use. |
| Secondary Parameters | None | | |
| Alarm Limits | None | | |
| Measured Value | O ₂ Use (L/min) | 0 to 70 | Shows when High Pressure Oxygen Supply is present and the consumption of flow. |
| FIO₂ Context Menu | | | |
| O ₂ Reservoir | Default: OFF | OFF/ON | “+” icon indicates when “ON” for low pressure O ₂ |

SpO₂ Parameter Window Options

The SpO₂ parameter window controls the Masimo Pulse Oximeter used in the ventilator. The SpO₂ measurement (0 to 100%) is shown in the parameter window and the Pleth waveform is plotted when the sensor is used. The parameter window displays a “--”.

Note: The pulse oximeter operates *only* when the ventilator is providing ventilation.

The following conditions can affect the pulse oximeter reading:

- The sensor is too tight.
- There is excessive illumination from light sources such as a surgical lamp, a bilirubin lamp, or sunlight.
- A blood pressure cuff is inflated on the same extremity as the one with a SpO₂ sensor attached.
- Poor perfusion
- The patient has hypotension, severe vasoconstriction, severe anemia, or hypothermia.
- There is an arterial occlusion proximal to the sensor.
- The patient is in cardiac arrest or is in shock.
- Patient movement
- Nail polish or finger pigment
- Carbon monoxide poisoning

The SpO₂ display is active only when the pulse oximeter is connected. The pulse oximeter is in standby (and displays *STBY* in the parameter window) when:

- No SpO₂ sensor is connected
- The sensor is off the patient during start up
- You place the pulse oximeter in standby

Note: You can place the pulse oximeter in standby only when the probe is disconnected from the patient. A valid signal automatically brings the pulse oximeter out of standby.

Secondary Parameters and Alarm Thresholds/Limits

Pressing the SpO₂ parameter button highlights the SpO₂ Low Limit secondary parameter and enables its setting to be changed. The SpO₂ Low Limit is the only secondary parameter for the SpO₂ parameter. The default SpO₂ Low Limit setting at start up is 94%.

The SpO₂ Low Limit is adjustable from 86% to 99% or can be set to OFF.

To change an SpO₂ Low Limit secondary parameter setting, follow these steps:

1. Press the SpO₂ parameter button until the SpO₂ Low Limit highlights.
2. Turn the **Dial** to adjust the setting (%).
3. Press the **Accept** button.

Context Menu

The Masimo context menu is the same for both the SpO₂ and HR parameter windows. The menu provides for the following pulse oximeter controls:

- Standby
- Pulse Ox
- Fast SAT
- Sensitivity
- APOD
- Averaging
- Signal Strength
- Signal IQ

The menu allows for the Pulse Oximeter monitoring to be placed in standby. It also provides options to turn on the fast SAT, adjust Sensitivity, and other Masimo specific parameters, see the table below for additional details.

To change a menu setting, follow these steps:

1. Press and hold the SpO₂ parameter button until the Context menu displays, then release the button.
2. Turn the **Dial** until the Context menu item you want to change highlights, then press the **Accept** button. The current setting for the selected item highlights.
3. Turn the **Dial** to adjust the value of the parameter.
4. Press the **Accept** button.

SpO₂ Parameter Window Reference

The following table provides the options and ranges for the SpO₂ Masimo context menu.

| SpO ₂ Parameter Window | | Options/Range | Availability/Notes |
|-----------------------------------|----------------------------|---|---|
| Primary Parameter | SpO ₂ % | 0 to 100 | Measurement only |
| Secondary Parameters | None | | |
| Alarm Limits | SpO ₂ Low Limit | 86 to 99, Off Default: 94% | |
| Measured Value | Pleth Waveform | | |
| Masimo Context Menu | | | |
| Pulse Ox | Default: Standby | Standby, Off, On | |
| Fast SAT | Default: Off | Off, On | Fast SAT enables rapid tracking of arterial oxygen saturation changes by minimizing the averaging. This mode is clinically applicable during procedures when detecting rapid changes in SpO ₂ is paramount such as induction, intubation, and sleep studies. |
| Sensitivity | Norm | Max, Norm | Norm adjusts the pleth signal sensitivity. Max interprets and displays data for even the weakest of signals. Max is recommended during procedures and when clinician and patient contact is continuous. |
| APOD | Off | Off, On | When on, this mode improves detection of the “probe off patient” condition, but reduces the ability to acquire a reading on patients of low perfusion. |
| Averaging | 8 Seconds | 2 to 4, 4 to 6, 8, 10, 12, 16 Seconds | Adjusts the SpO ₂ and HR averaging durations. |
| Signal Strength | Measured Value | 0 to 20 | Current signal strength value, not adjustable. A value of zero indicates that no measurement is available. This value helps clinicians place sensors on the optimal site. |
| Signal IQ | Measured Value | Bar Graph | Bar graph displays the relative reliability of the pulse oximeter signal. |

HR (Heart Rate)

The HR parameter window displays the patient's heart rate when the pulse oximeter is working and the sensor is attached. The HR measurement (0 to 240 beats per minute) is shown in the parameter window and the Pleth waveform is plotted when the pulse oximeter is used. During monitoring "--" displays when the sensor does not detect a measurement. The heart icon blinks at the pulse rate.

Secondary Parameters and Alarm Thresholds/Limits

The secondary parameters for the HR parameter window are the following:

- HR High Limit (adjustable from 80 to 240 beats per minute (or OFF))
- HR Low Limit (adjustable from 30 to 79 beats per minute (or OFF))

To change an alarm threshold setting, follow these steps:

1. Press the HR parameter button more than once until desired limit setting highlights.
2. Turn the **Dial** to adjust the value of the parameter.
3. Press the **Accept** button.

Context Menu

The menu supports both HR and SpO₂ parameter windows. The menu provides for the following pulse oximeter controls:

- Standby
- Pulse Ox
- Fast SAT
- Sensitivity
- APOD
- Averaging
- Signal Strength
- Signal IQ

The menu allows for the Pulse Oximeter monitoring to be placed in standby. It also provides options to turn on the fast SAT, adjust Sensitivity, and other Masimo specific parameters, see table below for additional details.

To change a menu setting, follow these steps:

1. Press and hold the HR parameter button until the menu displays.
2. Release the HR parameter button, turn the **Dial** until the Context menu item you want to change highlights, then press the **Accept** button. The current setting for the context menu parameter highlights.
3. Turn the **Dial** to change the setting to the desired value.
4. Press the **Accept** button.

HR Parameter Window Reference

The following table gives the options and ranges for the HR parameter:

| HR Parameter Window | | Options/Range | Availability/Notes |
|----------------------------|------------------|---|---|
| Primary Parameter | HR b/min | 0 to 255 | Measurement - Heart icon blinks at the pulse rate |
| Secondary Parameters | None | | |
| Alarm Limits | HR High Limit | 80 to 240, OFF | |
| | HR Low Limit | 30 to 79, OFF | |
| Masimo Context Menu | | | |
| Pulse Ox | Default: Standby | Standby, Off, On | |
| Fast SAT | Default: Off | Off, On | Fast SAT enables rapid tracking of arterial oxygen saturation changes by minimizing the averaging. This mode is clinically applicable during procedures when detecting rapid changes in SpO ₂ is paramount such as induction, intubation, and sleep studies. |
| Sensitivity | Norm | Max, Norm | Norm adjusts the pleth signal sensitivity. Max interprets and displays data for even the weakest of signals. Max is recommended during procedures and when clinician and patient contact is continuous. |
| APOD | Off | Off, On | When on, this mode improves detection of the "probe off patient" condition, but reduces the ability to acquire a reading on patients of low perfusion. |
| Averaging | 8 Seconds | 2 to 4, 4 to 6, 8, 10, 12, 16 Seconds | Adjusts the SpO ₂ and HR averaging durations. |
| Signal Strength | Measured Value | 0 to 20 | Current signal strength value, not adjustable. A value of zero indicates that no measurement is available. This value helps clinicians place sensors on optimal sites |
| Signal IQ | Measured Value | Bar Graph | Bar graph displays the relative reliability of the pulse oximeter signal. |

Manual Breath

The Manual Breath button enables the user to deliver a manual breath to a patient when pressed during the expiratory phase and then only after the airway pressure drops to the PEEP target.

The effect of the manual breath button depends on the ventilation mode set on the ventilator.

- In AC and SIMV*, a button press will deliver a mandatory breath defined by the settings.
- In CPAP and BL, it delivers a mandatory breath based on the Apnea Backup settings.

Figure 4-3 shows the Manual Breath Button on the EMV+ ventilator.

Note: If the ventilator supports the Plateau Pressure option, the button is labeled “Manual Breath/ P Plat”.

Note: SIMV mode is an optional mode and might not be available on your ventilator.

Plateau Pressure

Plateau pressure (P Plat) is the pressure applied to small airways and alveoli. It is measured during an inspiratory pause on the ventilator. Current clinical practice seeks to maintain the plateau pressure < 28-30 cm H₂O (hPa) to prevent excessive pressure in the lung.

Note: Plateau Pressure is an optional feature on the ventilator. If the ventilator supports the Plateau Pressure option, the Manual Breath button is labeled “Manual Breath/ P Plat” (see Figure 4-3). When Plateau Pressure is available on the EMV+ ventilator, the Manual Breath button performs two functions:

- Allow the user to deliver a manual breath
- Enables the user to perform a plateau pressure maneuver.

Plateau Pressure Maneuver

To perform a P Plat maneuver, press and hold the Manual Breath button during the inspiratory period. The maneuver is used during volume targeted breath. During pressure targeted breathing the PIP typically represents to alveolar pressure as flow decelerates to 0 l/min at the end of inspiration.

Holding the button past the end of inspiration during a mandatory breath causes the ventilator to delay opening the exhalation valve for as long as the button is held (up to 3 seconds).

During this period the ventilator measures the pressure while there is no gas flow. At the end of the period the exhalation valve opens and the device continues normal operation while the P plat is displayed for ~20s

The activation of a new alarm or pressing the Mute/Cancel button also clears the Plateau Pressure measurement.

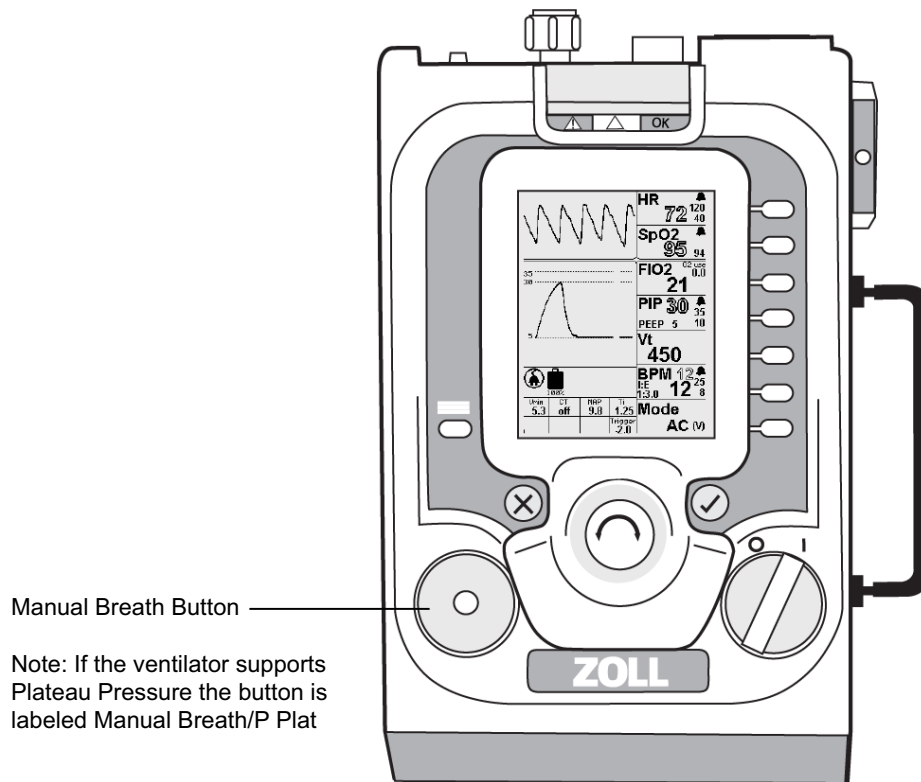

Figure 4-3 Manual Breath/Pressure Plateau Button

Popup Messages

To prevent the setting of parameter values that are outside the typical clinical range of settings, the ventilator presents popup messages that ask if you are sure you would like to set the parameter beyond the typical range. A sample popup message is shown in Figure 4-4.

When a message occurs, you are asked to press the **Accept** button before you can adjust a parameter beyond the typical range. Popup messages are also used to alert you that certain settings are not permitted or possible based on the current parameter settings. In addition, popup messages can call for you to press the **Accept** button to acknowledge that you are entering configurations where certain alarms are being suppressed, turned “off”, and/or canceled.

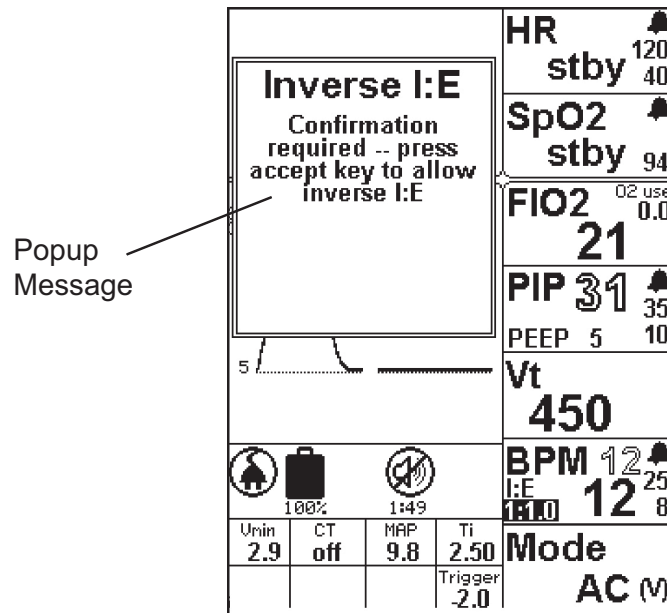

Figure 4-4 Popup Message Example

In addition to addressing setting conflicts, popup messages are used for confirmation (for example, alarms). These messages also appear whenever you attempt to adjust the ventilator in a way that is outside clinical norms or is outside its performance range.

Popup messages also appear when you are required to confirm their action before you proceed. For example, setting the BPM Low Limit setting below 4 would allow for 15 second apnea periods and would, in essence, disable the alarm for some patients. If the desired value is outside the performance range, the popup message alerts you to why you cannot make the change. (Example: trying to set the PEEP level greater than the PIP setting).

A list of all popup messages follows.

Popup Message List

| Popup/Information/Message |
|--|
| <p>Requested Compressor Flow Too Low</p> <p>Popup message triggers when the rate/tidal volume/FIO₂ combination requires a flow that is less than the flow capability of the compressor. Resolution involves changing a setting to increase the flow required from the compressor if possible. Note: this condition is only possible with infant setting and for FIO₂ < 25% at very low tidal volume with long inspiratory time.</p> <p>Message: Reduce FiO₂ , increase BPM, reduce I Time, or increase Vt</p> |
| <p>Requested Compressor Flow Too High</p> <p>Popup message triggers when the user attempts to adjust the ventilator so that flow from the compressor is > 100 l/min.</p> <p>Message: Cannot exceed 100 LPM total flow</p> |

| Popup/Information/Message |
|--|
| <p>Requested O₂ Flow Too Low</p> <p>Popup message triggers when the rate/tidal volume/FIO₂ combination requires a flow that is less than the flow capability of the O₂ valve. Resolution involves changing a setting to increase the flow required from the O₂ valve if possible.</p> <p>Note: This condition is only possible with infant setting and for FIO₂ < 25%.</p> <p>Message: Increase FiO₂ , increase BPM, reduce I Time, or increase Vt</p> |
| <p>Requested O₂ Flow Too High</p> <p>Popup message triggers when the user attempts to adjust the ventilator so that flow from the O₂ valve is > 100 l/min.</p> <p>Message: Cannot exceed 100 LPM total flow</p> |
| <p>Total Requested Flow Too High</p> <p>Popup message triggers when the user attempts to adjust the ventilator so that the combined flow from the compressor and O₂ valve is > 100 l/min.</p> <p>Message: Cannot exceed 100 LPM total flow</p> |
| <p>Total Requested Flow Too Low</p> <p>Popup message triggers when the user attempts to adjust the ventilator so that combined flow from the compressor and O₂ valve is < 2 l/min.</p> <p>Message: Cannot flow less than 2 LPM total flow</p> |
| <p>Alarm Disable</p> <p>Popup message triggers when the user attempts to adjust to disable an alarm by setting the value to 0 or the maximum value which would render the alarm essentially off.</p> <p>Message: Confirmation required -- press accept key to disable alarm</p> |
| <p>BPM Setting Conflict</p> <p>Popup message triggers when the user attempts to set the BPM to a value that would result in an inspiratory time (I Time) > 3 seconds.</p> <p>Message: I Time cannot exceed 3 seconds</p> |
| <p>BPM Setting Conflict</p> <p>Popup message triggers when the user attempts to set the BPM to a value that would result in an inspiratory time (I Time) > 5 seconds during inverse I:E ratio ventilation.</p> <p>Message: I Time cannot exceed 5 seconds with inverse I:E</p> |
| <p>E Time Range Exception</p> <p>Popup message triggers when the user attempts to set the BPM to a value that would result in an expiratory time (E Time) < 0.3 seconds.</p> <p>Message: E Time must be greater than 0.3 seconds</p> |

| Popup/Information/Message |
|--|
| <p>I:E Setting Conflict</p> <p>Popup message triggers when the user attempts to transition from AC mode using an inverse I:E ratio to another mode where inverse I:E is not allowed.</p> <p>Message: Inverse I:E only allowed in AC - Mode change will reset I:E to 1:3</p> |
| <p>I:E Setting Conflict</p> <p>Popup message triggers when the user attempts to set an inverse I:E ratio in an mode other than Assist/Control (AC).</p> <p>Message: Inverse I:E Not Allowed</p> |
| <p>BPM Setting Conflict</p> <p>Popup message triggers when the user attempts to set a BPM rate that will result in an I:E ratio > 1:99.</p> <p>Message: I:E > 1:99 not allowed</p> |
| <p>I Time Range Exception</p> <p>Popup message triggers when the user attempts to set inspiratory time (I Time) > 3 seconds during standard I:E ratio ventilation</p> <p>Message: I Time cannot exceed 3 seconds</p> |
| <p>I Time Range Exception</p> <p>Popup message triggers when the user attempts to SET inspiratory time (I Time) > 5 seconds during inverse I:E ratio ventilation.</p> <p>Message: I Time cannot exceed 5 seconds with inverse I:E</p> |
| <p>I Time Range Exception</p> <p>Popup message triggers when the user attempts to set an inspiratory time (I Time) < 0.1 seconds.</p> <p>Message: I Time must be greater than 0.1 seconds</p> |
| <p>I:E Range Exception</p> <p>Popup message triggers when the user attempts to set an inverse I:E ratio < 4:1.</p> <p>Message: I:E < 4:1 not allowed</p> |
| <p>I:E Range Exception</p> <p>Popup message triggers when the user attempts to set an I:E ratio > 1:99.</p> <p>Message: I:E > 1:99 not allowed</p> |
| <p>Vt Limit Conflict</p> <p>Popup message triggers when the user attempts to set Vt lower than the Vt Low Limit secondary parameter setting.</p> <p>Message: Cannot adjust Vt Set below Vt Low Alarm</p> |
| <p>Vt Limit Conflict</p> <p>Popup message triggers when the user attempts to set the Vt higher than the Vt High Limit secondary parameter setting.</p> <p>Message: Cannot adjust Vt Set above Vt High Limit</p> |

| Popup/Information/Message |
|---|
| <p>High Vt Setting</p> <p>Popup message triggers when the user attempts to set Vt > 1000 ml. To do this, the user must press the Accept button and then continue to set a value > 1000 ml followed by Accept again to confirm the setting change.</p> <p>Message: Confirmation required -- press accept key to allow Vt > 1000ml</p> |
| <p>PEEP Setting Conflict</p> <p>Popup message triggers when the user attempts to set the PEEP setting ≤ 5 cm H₂O (hPa) below the PIP High pressure limit.</p> <p>Message: Cannot adjust PEEP target to within 5 of PIP High Limits</p> |
| <p>PEEP Setting Conflict</p> <p>Popup message triggers when the user attempts to configure the ventilator so that the PEEP plus the pressure support (PS) are > the PIP High pressure limit.</p> <p>Message: PEEP + PS cannot be greater than PIP High Limit</p> |
| <p>PEEP Backup Setting Conflict</p> <p>Popup message triggers when the user attempts to set the PEEP setting ≤ 5 cm H₂O (hPa) below the Apnea Backup PIP pressure during CPAP or BL mode ventilation.</p> <p>Message: Cannot adjust PEEP target to within 5 of backup PIP target</p> |
| <p>PEEP Setting Conflict</p> <p>Popup message triggers when the user attempts to set the PEEP ≤ 5 cm H₂O (hPa) below PIP pressure.</p> <p>Message: Cannot adjust PEEP target to within 5 of PIP target</p> |
| <p>PEEP+PS Setting Conflict</p> <p>Popup message triggers when the user attempts to set a combination of PEEP and PS that is < 3 cm H₂O (hPa).</p> <p>Message: Cannot adjust PEEP+PS below 3</p> |
| <p>High Pressure Target Setting</p> <p>Popup message triggers when the user attempts to set the PIP pressure > 60 cm H₂O (hPa) . To do this, the user must press the Accept button and then continue to set a value > 60 cm H₂O (hPa) followed by Accept again to confirm the setting change.</p> <p>Message: Confirmation required -- press accept key to exceed 60 cm H₂O (hPa)</p> |
| <p>PIP Setting Conflict</p> <p>Popup message triggers when the user attempts to set the PIP target ≤ 5 of PEEP pressure.</p> <p>Message: Cannot adjust PIP target to less than 5 more than PEEP</p> |
| <p>PIP Setting Conflict</p> <p>Popup message triggers when the user attempts to set the PIP > the PIP High pressure limit.</p> <p>Message: Cannot adjust PIP target higher than PIP High Limit</p> |

| Popup/Information/Message |
|---|
| <p>BPM Limit Conflict</p> <p>Popup message triggers when the user attempts to set the BPM High Limit < the BPM Low Limit. Message: Cannot adjust high limit lower than low limit</p> |
| <p>Low Breath Rate Setting</p> <p>Popup message triggers when the user attempts to set the BPM < 6 bpm. Doing this could, in effect, disable the alarm for some patients. To do this, the user must press the Accept button and then continue to set a value < 6 bpm followed by Accept again to confirm the setting change. Message: Confirmation required -- press accept key for values below 6 BPM</p> |
| <p>BPM Limit Conflict</p> <p>Popup message triggers when the user attempts to set the BPM Low Limit > the BPM High limit. Message: Cannot adjust low limit higher than high limit</p> |
| <p>Vt Limit Conflict</p> <p>Popup message triggers when the user attempts to set the Vt High Limit < the Vt Low Limit. Message: Cannot adjust high limit lower than low limit</p> |
| <p>Vt Limit Backup Setting Conflict</p> <p>Popup message triggers during CPAP or BL mode when the user attempts to set the Vt High Limit < the Vt setting in the Apnea Backup settings. Message: Cannot adjust high limit lower than Backup Vt Setting</p> |
| <p>Vt Limit Conflict</p> <p>Popup message triggers when the user attempts to set the Vt High Limit < the Vt setting. Message: Cannot adjust high limit lower than Vt Setting</p> |
| <p>High Vt Limit Setting</p> <p>Popup message triggers when the user attempts to set the Vt limit > 1500 ml. Doing this could, in effect, disable the alarm for some patients. To do this, the user must press the Accept button and then continue to set a value > 1500 ml followed by Accept again to confirm the setting change. Message: Confirmation required -- press accept key for values above 1500ml</p> |
| <p>Vt Limit Conflict</p> <p>Popup message triggers when the user attempts to set the Vt Low Limit > Vt High Limit. Message: Cannot adjust low limit higher than high limit</p> |
| <p>Vt Limit Conflict</p> <p>Popup message triggers during SIMV (V) when the user attempts to set the Vt Low Limit > the current Vt. Message: Cannot adjust low limit higher than Vt Setting</p> |
| <p>Vt Limit Backup Setting Conflict</p> <p>Popup message triggers during CPAP or BL mode when the user attempts to set the Vt Low Limit > the Vt setting in the Apnea Backup settings. Message: Cannot adjust low limit higher than Backup Vt Setting.</p> |

| Popup/Information/Message |
|--|
| <p>High Pressure Limit Setting</p> <p>Popup message triggers when the user attempts to set the PIP > 60 cm H₂O (hPa). To do this, the user must press the Accept button and then continue to set a PIP > 60 cm H₂O (hPa) followed by Accept again to confirm the setting change.</p> <p>Message: Confirmation required -- press accept key to exceed 60 cm H₂O (hPa)</p> |
| <p>PIP Limit Conflict</p> <p>Popup message triggers when the user attempts to set the PIP High Limit < the PIP Low Limit.</p> <p>Message: Cannot adjust high limit lower than low limit</p> |
| <p>PIP Limit Backup Setting Conflict</p> <p>Popup message triggers during CPAP or BL mode when the user attempts to set the PIP High Limit < Apnea Backup PIP limit.</p> <p>Message: Cannot adjust high limit lower than backup PIP target</p> |
| <p>PIP Limit Conflict</p> <p>Popup message triggers when the user attempts to set the PIP High Limit < the PIP Low Limit.</p> <p>Message: Cannot adjust high limit lower than PIP target</p> |
| <p>PIP Limit Conflict</p> <p>Popup message triggers when the user attempts to set the PIP High Limit < the combination of PS and PEEP pressures.</p> <p>Message: Cannot adjust high limit lower than PS + PEEP</p> |
| <p>PIP Limit Conflict</p> <p>Popup message triggers when the user attempts to set the PIP Low Limit > the PIP High Limit.</p> <p>Message: Cannot adjust low limit higher than high limit</p> |
| <p>Heart Rate Limit Conflict</p> <p>Popup message triggers when the user attempts to set the HR High Limit < the HR Low Limit.</p> <p>Message: Cannot adjust high limit lower than low limit</p> |
| <p>Heart Rate Limit Conflict</p> <p>Popup message triggers when the user attempts to set the HR Low Limit > the HR High Limit.</p> <p>Message: Cannot adjust low limit higher than high limit</p> |
| <p>PS Conflict</p> <p>Popup message triggers when the user attempts to set the PS > the PIP High Limit - PEEP pressure.</p> <p>Message: Cannot adjust PS higher than PIP High Limit - PEEP</p> |
| <p>Leak Comp.</p> <p>Popup message triggers when the user attempts to initiate leak compensation (LC). To do this, the user must press the Accept button and then select LC followed by Accept again to confirm the setting change.</p> <p>Message: Some Alarms Disabled! Configure Alarms for Patient!</p> |

| Popup/Information/Message |
|--|
| <p>Mode Conflict</p> <p>Popup message triggers when the user attempts to initiate leak compensation (LC) during volume targeted ventilation. Note: LC is only available during pressure targeted ventilation.</p> <p>Message: Cannot select Volume targeted control breaths with Leak Compensation on -- first turn Leak Compensation off</p> |
| <p>Inverse I:E</p> <p>Popup message triggers when the user attempts to set an inverse I:E ratio. To do this, the user must press the Accept button and then adjust the I:E ratio to the desired inverse value and press Accept again to confirm the setting change.</p> <p>Message: Confirmation required -- press accept key to allow inverse I:E</p> |
| <p>Excessive Volume for Infant Circuit</p> <p>Popup message triggers when the user attempts to set a $V_t > 300$ ml when the tubing compliance compensation is set to Pediatric.</p> <p>Message: Press accept to confirm use of adult circuit</p> |
| <p>Insufficient Volume for Adult/Ped Circuit</p> <p>Popup message triggers when the user attempts to set a $V_t < 200$ ml when the tubing compliance compensation is set to Adult.</p> <p>Message: Press accept to confirm use of infant circuit</p> |
| <p>High PEEP Setting</p> <p>Popup message triggers during CPAP mode when the user attempts to set the PEEP > 15 cm H₂O (hPa). To do this, the user must press the Accept button and then adjust PEEP to the desired value and press Accept again to confirm the setting change.</p> <p>Message: Confirmation required -- press accept key to allow PEEP above 15</p> |
| <p>High EPAP Setting</p> <p>Popup message triggers during BL mode when the user attempts to set the EPAP > 15 cm H₂O (hPa). To do this, the user must press the Accept button and then adjust PEEP to the desired value and press Accept again to confirm the setting change.</p> <p>Message: Confirmation required -- press accept key to allow EPAP above 15</p> |
| <p>EPAP Setting Conflict</p> <p>Popup message triggers during BL mode when the user attempts to set the EPAP < 3 cm H₂O (hPa) below the IPAP target.</p> <p>Message: Cannot adjust EPAP target to within 3 of IPAP target</p> |
| <p>EPAP Setting Conflict</p> <p>Popup message triggers during BL mode when the user attempts to set the EPAP < 5 cm H₂O (hPa) below the Apnea Backup PIP target.</p> <p>Message: Cannot adjust EPAP target to within 5 of backup PIP</p> |
| <p>PIP Limit Conflict</p> <p>Popup message triggers during BL mode when the user attempts to set the PIP Limit) $<$ the IPAP target.</p> <p>Message: Cannot adjust high limit lower than IPAP target</p> |

| Popup/Information/Message |
|---|
| <p>IPAP Setting Conflict</p> <p>Popup message triggers during BL mode when the user attempts to set the IPAP < 3 cm H₂O (hPa) above the EPAP setting.</p> <p>Message: Cannot adjust IPAP target to less than 3 more than EPAP</p> |
| <p>IPAP Setting Conflict</p> <p>Popup message triggers during BL mode when the user attempts to set the IPAP < the PIP limit.</p> <p>Message: Cannot adjust IPAP target higher than PIP High Limit</p> |
| <p>High IPAP Setting</p> <p>Popup message triggers during BL mode when the user attempts to set the IPAP > 30 cm H₂O (hPa). To do this, the user must press the Accept button and then adjust IPAP to the desired value and press Accept again to confirm the setting change.</p> <p>Message: Confirmation required -- press accept key to allow IPAP above 30 cm H₂O (hPa)</p> |
| <p>High PEEP+PS Setting</p> <p>Popup message triggers in CPAP mode when the user attempts to set the combination of PEEP + PS < 30 cm H₂O. To do this, the user must press the Accept button and then adjust PEEP or PS to the desired value and press Accept again to confirm the setting change.</p> <p>Message: Confirmation required -- press accept key to allow PEEP+PS above 30 cm H₂O (hPa)</p> |
| <p>High Pressure Limit Setting</p> <p>Popup message triggers when the Start Menu is active and the user selects either the Custom or Last Setting options and the PIP High Limit is >35 cm H₂O. When the user selects one of the options where this is true, the popup message is triggered requiring the user to provide additional conformation, pressing Accept, to initiate ventilation with the option.</p> <p>Message: Confirmation required -- press accept key to recall limit setting above 35 cm H₂O (hPa)</p> |

Transitions

When transitioning between modes, or between volume and pressure targeting the ventilator may adjust or set any of the following parameters:

- BPM, BPM High Limit, BPM Low Limit
- VT, VT High Limit, VT Low Limit
- PIP, PIP High Limit, PIP Low Limit
- PEEP
- PS / IPAP
- I:E Ratio / Ti
- Rise Time
- LC

These parameters are adjusted or populated to safely transition to the newmode. After changing the mode or ventilation target, the parameters and alarm limits should be adjusted appropriately for the patient being ventilated. In cases where significant change is required, the patient should be manually ventilated while the ventilator is adjusted and all parameters are confirmed before reconnecting the patient to the ventilator.

Reference Appendix E for detailed description of these transitions.

Warning! The alarm limits must be appropriate for the patient being ventilated. If a parameter is changed, adjust the high and low alarm limit to bracket the selected value.

Warning! Transition into CPAP or BL modes automatically adjusts the rise time and always needs to be checked since the setting might need further adjustment based on the patient’s respiratory mechanics or ventilation pattern. Before using the ventilator with an infant or small child, you should always configure the ventilator appropriately before attaching the patient. Always monitor the patient to ensure optimal support.

Using the Menu

The **Menu** button displays the Menu, which allows you to change various ventilator options, such as the contrast or brightness of the Display Screen (*LCD Contrast/LCD Brightness*).

When you press the **Menu** button, the Menu appears:

- Alarm Config
- Powerup Settings
- LCD Contrast
- LCD Brightness
- UTC Offset
- Unit Info
- Alarm History

Alarm Configuration

Selecting Alarm Configuration allows the user to enable or disable the audible and visible alerts associated with specific alarms to prevent nuisance alarms.

Refer to, “Managing Alarms” in Chapter 5.

Powerup

You can configure how the ventilator starts (powers up) based on your use or patient population. The Powerup settings include:

| Powerup Setting (Option) | Setting Choices |
|--------------------------|--|
| Powerup | Adult, Pediatric, or Start Menu |
| Custom Settings | Saves the currently set operating parameters |
| Language | English, Language Option |

In addition to controlling how the ventilator starts up, the Powerup settings sub-menu also allows the user to save the current ventilator configuration for use as the Custom starting configuration and which language will be used when the ventilator is turned ON.

Specifying Powerup Settings

To configure new Powerup settings, follow these steps:

1. Press the **Menu** button to display the menu, then turn the **Dial** to highlight the Powerup settings.
2. Press the **Accept** button. The following list of configurable items with **Powerup** highlighted displays.
 - Powerup
 - Custom Settings
 - Language
3. Press the **Accept** button, then turn the **Dial** to the desired starting configuration.
 - Adult Settings
 - Pediatric Settings
 - Start Menu
4. Press the **Accept** button to confirm the new starting configuration.
5. Press the **Mute/Cancel** button to return to the Menu.
6. Press the **Mute/Cancel** button again to return to the configured Powerup setting (Start menu, Adult, or Pediatric).

Specifying Custom Settings

To save the current configuration parameter settings (if different than Adult or Pediatric default parameter settings) for use at start up, follow these steps:

1. Press the **Menu** button, then turn the **Dial** to **Powerup Settings**, then press the **Accept** button.
2. Turn the **Dial** to highlight the **Custom Settings** choice, and then press the **Accept** button (**Save** becomes highlighted).
3. Press the **Accept** button again to save the current parameter settings.
4. Press the **Mute/Cancel** button to return to the menu.
5. Press the **Mute/Cancel** button again to return to the configured Powerup setting (Start Menu, Adult, or Pediatric).

Specifying a Language

The ventilator is provided with the English language and a local language. (This feature is limited to ventilators with multiple languages.).

LCD Contrast

The LCD Contrast submenu allows the user to adjust the contrast of the ventilator display screen to optimize visibility in the current lighting environment. Given the use environment, the ventilator automatically compensates for the temperature changes that can effect LCD performance. However, in temperatures outside its performance specification of -26 to 55 °C (15 to 131 °F), or when the ventilator temperature is rapidly changing (warm storage into a very cold environment) the contrast can fade making viewing difficult.

To adjust the LCD screen contrast, follow these steps:

1. Press the **Menu** button to display the Menu.
2. Turn the **Dial** to highlight **LCD Contrast**, and then press the **Accept** button.

3. Turn the **Dial** clockwise to increase contrast (counterclockwise to decrease it) while watching the LCD screen to determine the best contrast value based on visibility, then press the **Accept** button to set the new contrast value.
4. Press the **Mute/Cancel** button to return to the Menu.

Note: The contrast value is saved between uses. This may require adjusting the contrast value when the temperature is within the ventilator's operating range or with the next use.

In the event the LCD is not viewable due to extreme temperature conditions there is a short cut to the contrast control. Press and hold the **Menu** button for 2 to 3 seconds. Doing this, jumps the menu highlight directly to the contrast control where the contrast can be adjust as described above.

LCD Brightness

The LCD Brightness control allows the user to adjust the brightness of the LCD display screen and LED Array to optimize visibility in the current lighting environment.

The initial numerical value is 25. The brightness ranges from 0 to 32.

To adjust the brightness, follow these steps:

1. Press the **Menu** button to display the menu.
2. Turn the **Dial** to highlight **LCD Brightness**, and then press the **Accept** button.
3. Turn the **Dial** clockwise to increase brightness (counterclockwise to decrease it) while watching the LCD screen and LED Array to determine the best brightness value based on visibility, then press the **Accept** button to set the new brightness value.
4. Press the **Mute/Cancel** button to return to the Menu.

Note: This feature is not available on all ventilator models.

UTC Offset

The UTC Offset control allows the user to set the ventilator clock to match the local time zone relative to Coordinated Universal Time (UTC). Matching the local time zone through the UTC Offset setting allows an accurate time record of events recorded in the alarm log.

Before setting the UTC Offset, the user must know the UTC Offset value for your timezone. When determining the UTC Offset value, remember to consider variances for Daylight Saving Time (DST).

Once set, the setting is retained until:

- You change the setting (required for daylight savings time)
- The ventilator is serviced.

To adjust the UTC Offset, follow these steps:

1. Press the **Menu** button to display the Menu.
2. Turn the **Dial** to highlight **UTC Offset**, and then press the **Accept** button.
3. Turn the **Dial** clockwise or counterclockwise to find the offset value for your timezone, then press the **Accept** button to set the new contrast value.
4. Press the **Mute/Cancel** button to return to the Menu.

Note: The UTC offset changes the time (min/max of 12 hrs). This offset is only applied to the time, not to the date stored in the device.

Unit Info

The Unit Info choice allows the user to view the following information about the ventilator as follows:

| Item | Description |
|----------------|---|
| Use Statistics | Provides access to ventilator usage in hours and minutes. |
| Date | The current calendar date |
| Cal Date | Last date the calibration was checked |
| PM Cycle | Annual |
| SPM SW Rev | Software revision of the Smart Pneumatic Module |
| SPM SN | Serial number of the Smart Pneumatic Module |
| SPM Model | Smart Pneumatic Module model |
| EMV Soft Rev | Software revision of the ventilator model |
| Device SN | Serial number of the ventilator model |
| Device Model | Ventilator model |

To view unit information for the ventilator, follow these steps:

1. Press the **Menu** button to display the Menu.
2. Turn the **Dial** to highlight **Unit Info**, and then press the **Accept** button. The list of information displays with **Use Statistics** highlighted.
3. Press the **Accept** button to display ventilator usage in hours and minutes (*hh:mm*)
4. Press the **Mute/Cancel** button to return to the Menu.

Alarm History

The Alarm History provides a list of the alarm messages generated by the ventilator during use.

The history holds a maximum of 256 events.

Note: Power cycling does not clear the alarm history.

Each list entry provides the following information

- The Alarm Name
- The Service Code
- The calendar date when the event was entered
- Whether the alarm is set or cleared
- The time (24hr) when the event was entered
- The log entry number <NNN> The higher the number the more recent the alarm message event was logged

To display the Alarm History, follow these steps:

1. Press the **Menu** button to display the Menu.
2. Turn the **Dial** to highlight **Alarm History**, and then press the **Accept** button. The most recent history entry displays.
3. Turn the **Dial** counterclockwise to view earlier entries. Turn the **Dial** clockwise to view more recent entries.
4. Press the **Mute/Cancel** button to return to the Menu.
5. Press the **Mute/Cancel** button again to return to the user interface.

The alarm condition is not logged when alarm is active but not displayed (due to other higher priority alarm indication as explained in the Alarms Chapter of this manual), or if the alarm is disabled in the alarm configuration the condition is not logged.

The "Complete Power Failure" alarm occurs when no power is provided to the ventilator (See Chapter 5). This alarm is not triggered by software and is not recorded in the alarm log.

Chapter 5

Alarms

This chapter provides a detailed description and comprehensive reference for ZOLL ventilator's alarms. This chapter addresses the following:

- Describes alarm types and priorities
- Provides a comprehensive list of alarms

Alarm Overview

To safeguard the patient, the ventilator continuously monitors the patient, device, and environment to ensure that all the systems are functioning as intended. When device detects a problem, it triggers an alarm to alert the user and displays a Smart Help message to assist the user in resolving the alarm. Smart Help presents a multi-line message in the upper left-hand corner of the display screen.

This screen area is the Alarm Message Center (AMC) and the following information displays in it.

- The alarm name
- Smart Help information which is a series of instructions to help you resolve the alarm.

The ventilator prioritizes alarms based on the risk to the patient and always presents the alarm with the greatest risk to the patient first. All Smart Help messages are context-based and suggest what is causing the alarm, as well as show how it can be resolved.

The Alarm Message Center (AMC) contains the information and instructions for all active alarms, as shown in Figure 5-1.

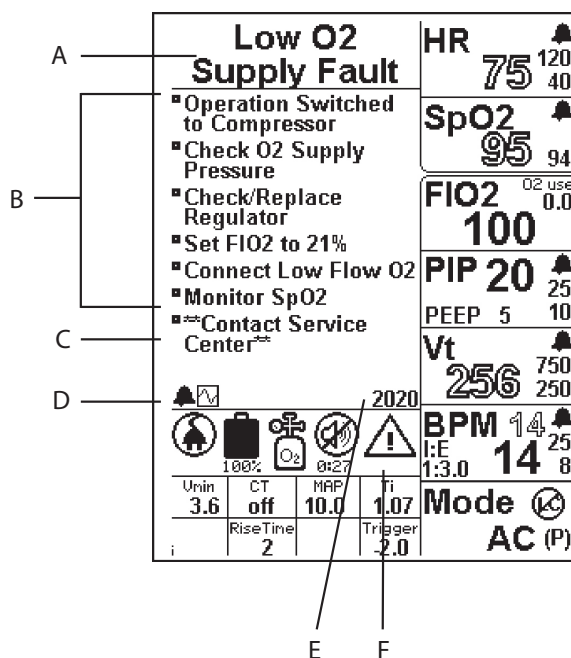

Figure 5-1 Smart Help Alarm Display

- A. **Alarm Name:** describes the type or cause of the alarm. When more than one alarm occurs at the same time, the device prioritizes the alarms based on the highest risk to the patient.
- B. **Mitigation/Resolution:** prioritized instructions that give more information about the nature of the alarm and describe how to resolve the alarm state.
- C. **If Not Resolved Instructions:** instructions for what to do you cannot resolve the alarm state. The instruction is always shown in the following format ***Message...***.
- D. **Alarm Icons:** for each active alarm, an alarm bell appears. When multiple alarms are active, the number of bells corresponds to the number of alarms. The alarm in the AMC is displayed as the solid bell. To view each active alarm, turn the **Dial** to scroll through all active alarms. The plot icon is also in this list. It allows you to see the current waveform to better assess the nature of the failure. A maximum of five alarms can be displayed without the plot icon.
- E. **Service Code (SC):** each alarm has a 4 digit number associated with it, which helps the user indicate the specific alarm when communicating with technical support. Service Codes appear in the following format:
- | | |
|------|-----------------------|
| 1### | High Priority Alarm |
| 2### | Medium Priority Alarm |
| 3### | Low Priority Alarm |
- F. **Attention Warning Icon:** identifies the severity of the alarm: Low, Medium, or High priority. See the Symbols table in Chapter 1 for the appearance of the warning triangle for each of these three alarms.

Muting Alarms

During device operation, the mute behavior depends on the alarm priority (see section below). There are other mute behaviors used by the alarm system. See “Managing Alarms” for Preemptive Mute and Startup Mute descriptions.

Warning! **Use in High Noise Environments** — in high noise environments, you may be inclined not to mute the alarm while addressing the problem. Not pressing Mute limits the user's ability to resolve the alarm because with each breath the alarm is re-triggered and any parameter changes you are attempting are canceled as the alarm re-triggers.

Alarm Priorities

Alarm priorities define the operational status of the device and its ability to provide mechanical ventilation. The alarm priorities are as follows:

High Priority

Mechanical ventilation under user control is no longer possible. This alarm priority requires immediate intervention indicated by fast red blinking alarm LED and audio signal. This includes system failure alarms where the CPU has failed and a backup has taken over to sound the audible and visual alarms. It can also occur when the device is turned on and there is no internal or external power source.

Pressing the **Mute/Cancel** button has no effect on a high priority alarm. The alarm can only be silenced by turning off the ventilator. Some alarms can be resolved by turning the ventilator off, then on again.

Medium Priority

Mechanical ventilation is active or is possible (maybe for a finite period of time) but, there is a failure or fault with the patient, ventilator circuit, a pneumatic subsystem, or pulse oximeter. This alarm priority requires immediate intervention by the user indicated by a slow red blinking alarm LED and audio signal.

Pressing the **Mute/Cancel** button mutes medium priority alarms for 30 seconds. If the alarm trigger still exists after 30 seconds, the audible alarm recurs until you mute it again for another 30 second period or the alarm is resolved.

Low Priority (Advisory)

Safe mechanical ventilation is active but, there is a fault that you must be aware of to ensure safe management of the patient or ventilator. Low priority alarms present with both an audible and yellow alarm LED signal (slow blink) alerting you to the condition.

Pressing the **Mute/Cancel** button cancels the audible signal. If the alarm is not resolved, the yellow LED remains illuminated to remind you of the fault or failure.

Note: Some Low Priority alarms are canceled and the Alarm LED turns green when you push the **Mute/Cancel** button. For others, the audible alarm is canceled but the Alarm LED stays yellow to remind you that the device is operating in a state that needs monitoring.

Popup Messages

As described in Chapter 4, popup messages are used to help the user make alarm adjustments and prevent unintended adjustment of the device. See Chapter 4 for a list of popup messages.

Alarm Types

Alarm types are identified to provide a framework for the alarm scheme and titles. The alarm indication may be due to patient conditions, breathing circuit conditions, device conditions, or environment. For a list of all alarms, with descriptions of ventilator behavior and mitigation actions see Alarm Summary section later in this chapter.

The alarm types are:

- Patient Safety — address the ventilation of the patient and their respiratory effort. Patient Safety alarm types also includes: pulse oximetry monitoring and circuit/exhalation valve issues.
- Environmental and Use — address the device inputs: external power, battery, high pressure O₂ supply, and the fresh gas intake. Environmental and Use alarm types also includes: ambient and device temperature, barometric pressure, and altitude.
- Self Check — address the performance of the device systems and include:
 - Internal Communication (Comm): faults/failures of inter-device communication, cyclic redundancy checking, or processor-related issues
 - Pneumatic Sensor: faults/failures of the pneumotachographs that measure gas flow or the pressure transducers.
 - Pneumatic System: faults/failures of the compressor or O₂ supply valve.
 - Power System: faults/failures of the power system that render the device unable to operate from external power or charge/operate from the internal rechargeable battery.
 - Pulse Oximeter Module: faults/failures of the pulse oximeter module that are not related to monitoring of the patient, a fault or failure of the module.
 - Preventive Maintenance: alarms that occur when device is due for preventive maintenance.

Patient Safety Alarm Type

The ventilation mode determines whether parameters are controlled by the user. As a result, the alarms monitoring the patient safety behave differently based on the ventilation mode. Patient safety alarms may be muted or turned off if the use determines this is appropriate for the management of the patient.

Note: Popup messages are used to prevent inadvertent setting of alarm limits at their extreme which could limit the effectiveness of the alarm.

The table below lists alarms related to patient safety, describes default settings and adjustable ranges in different ventilation modes and provides the Service Code (SC) number for each alarm. Alarm settings are retained if set prior to power loss and can be retrieved by following the Using the Last Setting instructions in Chapter 4.

| Alarm Name | Adjustable Range, Default | Service Code |
|--|---|--------------|
| Airway Pressure High | 20 to 100 (>60 requires confirmation) Default: Adult:35 Pediatric: 30 | 2070 |
| Low Airway Pressure | 3 to 35, OFF (with popup confirmation; 3 without confirmation) Default: 10 in AC, SIMV Default: OFF in CPAP or BL See transition and feature notes in Chapter 4. | 2071 |
| High Tidal Volume (Vt High) (ml) | 0 to 2000, OFF (with popup confirmation; 2000 without confirmation) Default: Adult: N/A Pediatric: 500 Default: OFF in CPAP or BL See transition and feature notes in Chapter 4. | 2072 |
| Low Tidal Volume (Vt Low) (ml) | 0 to 2000, OFF (with popup confirmation; 0 without confirmation) Default: Adult: N/A Pediatric: 500 Default: OFF in CPAP or BL See transition and feature notes in Chapter 4. | 2073 |
| High Breath Rate | 20 to 99, OFF (with popup confirmation; 99 without confirmation) Default: Adult: 25 Pediatric: 30 | 2074 |
| Low Breath Rate/Apnea | 2 to 25 (with popup confirmation below 6) | 2075 |
| Apnea | Default: Adult: 8 Pediatric: 10 | 2076 |
| PEEP Leak | Not adjustable, OFF (with Alarm Menu) | 2090 |
| Insufficient Flow | Not adjustable | 2095 |
| Spont. Breath PIP High | 20 to 100 Default = Adult:35 Pediatric: 30 | 2170 |
| Spont. Breath PIP Low | 3 to 35, OFF (with popup confirmation; 3 without confirmation) Default: 10 in AC, SIMV Default: OFF in CPAP or BL See transition and feature notes in Chapter 4. | 2171 |

| Alarm Name | Adjustable Range, Default | Service Code |
|---|---|--------------|
| Spont. Breath-VT High | 0 to 2000, OFF (with popup confirmation; 2000 without confirmation) Default: Adult: N/A Pediatric: 500 Default: OFF in CPAP or BL See transition and feature notes in Chapter 4. | 2172 |
| Spont. Breath-VT Low | 0 to 2000, OFF (with popup Confirmation; 0 without confirmation) Default: Adult: N/A Pediatric: 500 Default: OFF in CPAP or BL See transition and feature notes in Chapter 4. | 2173 |
| Inspiratory Demand | Not adjustable, OFF (with Alarm Menu) | 3092 |
| Auto-PEEP | Not adjustable, OFF (with Alarm Menu) | 3091 |
| Patient Disconnect | Not adjustable | 2100 |
| Exhalation System Failure | Not adjustable | 1060 |
| Exhalation System Failure | Not adjustable | 1061 |
| Exhalation System Fault | Not adjustable | 2062 |
| Self Check Failure (Pneumatic Sensor: Autocal) | Not adjustable | 1051 |
| Self Check Fault (Pneumatic Sensor: Airway Pressure) | Not adjustable | 2053 |
| Tubing Compliance Fault | Not adjustable | 3073 |

Patient Safety Alarms Related to Use of a Pulse Oximeter

The primary use of the ventilator is to provide patient ventilation; however, the ventilator has an integrated pulse oximeter. The pulse oximeter operates only when the ventilator is ventilating. When there is an issue with the SpO₂ or HR signals or the value is outside of the alarm limits the device triggers alarms as identified in the table below.

Note: Pulse oximetry is not available when the Start Menu is active, only after ventilation is started.

| Alarm Name | Adjustable Range, Default | Service Code |
|--------------------------------|--|--------------|
| Pulse Ox Sensor Off Patient | Not adjustable, OFF (with alarm menu) | 2314 |
| SpO ₂ Low | 86 to 99, (with popup confirmation; 86 without confirmation) Default: 94 | 2401 |
| Heart Rate High | 80 to 240, OFF (with popup confirmation; 240 without confirmation) Default: Adult: 120 Pediatric: 150 | 2410 |
| Heart Rate Low | 30 to 79, OFF (with popup confirmation; 30 without confirmation) Default: 40 | 2411 |
| Pulse Ox Sensor Not Connected | Not adjustable | 3310 |
| Defective Pulse Ox Sensor | Not adjustable, OFF | 3311 |
| Pulse Search | Not adjustable, OFF | 3312 |
| Pulse Ox Signal Interference | Not adjustable, OFF | 3313 |
| Ambient Light Fault | Not adjustable, OFF | 3315 |
| Invalid Pulse Ox Sensor | Not adjustable, OFF | 3316 |
| Low SpO ₂ Perfusion | Not adjustable, OFF | 3317 3318 |

Environmental and Use Alarm Types

Environmental and Use alarms result from a ventilator fault or failure (for example, the ventilator's battery is drained) or from a change in use (for example, an external O₂ tank requires replacement).

Note: The alarm priority is dependent on whether an alternate power or gas source is available

These alarms clear when the environmental or use condition is corrected. (for example, external power is supplied or external O₂ is restored)

Note: Environmental and Use alarms cannot be preemptively muted or muted at Start Up. Additionally, these alarms cannot be turned OFF or adjusted. The user must correct the cause of the alarm or change the therapy.

The table that follows lists the Environmental and Use alarms. They are grouped based on their condition and effect on the ventilator.

| Environmental and Use Alarm Types | Alarm Group | Service Code(s) |
|-----------------------------------|--|------------------------------|
| Battery | Battery State of Charge | 1430 2430 3430 3431 |
| | Battery Charge Fault/Failure | 2423 3423 3422 |
| | Nearly Too Hot for discharge | 2450 3450 |
| | Too hot for charge/discharge w/ external power | 3451 3452 |
| | Too Cold for charge | 3453 |
| | | |
| Power Fault/Failure | External Power Failure | 3431 |
| | Insufficient Current | 3442 |
| | High Voltage | 3441 |
| | DC Power Reversed | 3444 |
| | Disconnect/Low Voltage | 3421 |
| | | |
| Climatic Environment Fault | Altitude Too High/Low | 3131 3132 |
| | Temperature Too High/Low | 3140 3141 |
| | | |
| O ₂ Supply | Low O ₂ Supply Failure/ Fault | 1020 2020 |
| | High O ₂ Supply Failure/Fault | 1041 3041 |
| | | |

| Environmental and Use Alarm Types | Alarm Group | Service Code(s) |
|-----------------------------------|----------------------------------|------------------------------|
| Gas Intake Fault | Gas Intake Blocked or Restricted | 1030 2030 3030 3031 |

Complete Power Failure

In event the ventilator is operating and it detects that there is no internal power and there is no external power the device will issue a “Complete Power Failure” alarm for two minutes. For this alarm there is no LCD indication, the Red LED blinks, and the buzzer sounds for two minutes. The alarm clears with a user acknowledgment of turning the power switch to OFF. This alarm is not recorded in the alarm history file. All other alarms are recorded in the alarm history file prior to the complete power failure.

Self-Check Alarm Types

During power up, the ventilator goes through a Self-Check Test (a set of system tests and checks). When the Self-Check passes, the LED array turns green and the Start Menu displays, indicating that the ventilator is operational.

If the Self-Check does not pass, then one or more Self-Check alarms present to identify the nature of the problem.

Warning! **Unresolved Self-Check alarms alert the user to issues with the device that can affect its performance. Users should carefully consider the risk of using the device with these alarms before using it with a patient.**

Note: The alarm priority is dependent on whether an alternate power or gas source is detected.

The device continually self-monitors to ensure hardware functionality and minimize software errors. A Self-Check alarm is triggered when a fault or failure condition is detected. These alarms clear when the condition reported by the alarm is corrected. (for example, an internal communication failure.)

Note: Self-Check alarms cannot be preemptively muted or muted at Start Up.

The table that follows lists the Self-Check alarms.

| Self Check Alarm Types | Group(s) | Related Service Code(s) |
|--------------------------|---|------------------------------|
| Communication | Internal COMM CPU - SPM | 1176 1173 |
| | Internal COMM CPU | 1471 1475 |
| | Internal COMM SPM | 1175 1472 1474 |
| | | |
| Pneumatic System Failure | Compressor Flow Path (Failure/Faults) | 1001 2001 3001 |
| | Internal COMM Compressor (Failure/Faults) | 1002 2002 3002 |
| | O ₂ Valve Failure | 1010 |
| | O ₂ Flow Path (Failure/Faults) | 1011 2011 3011 |
| | Internal COMM Valve (Failure/Faults) | 1012 2012 3012 3172 |
| | Sensor/Transducers/Cal file Failures | 1003 1052 1174 |
| | Sensor and Transducers Faults | 3143 3130 3032 |

| Self Check Alarm Types | Group(s) | Related Service Code(s) |
|--------------------------------|---|-------------------------|
| Power System Fault/ Failure | 5V Bus Compromised | 1172 |
| | No Back Up power available Input Protection Circuit Failure | 2421 |
| | Internal COMM Battery Faults | 2455 |
| | Back Up power available | 3455 |
| | Internal COMM Power Components Fault | 3470 |
| | | |
| Pulse Ox - Module Failure | Internal OEM Board (In Use/Not in Use) | 2300 |
| | | 3300 |
| | Internal COMM (In Use/Not in Use) | 2301 |
| | | 3301 |
| | | |
| Preventive Maintenance (PM) | PM Due <ul style="list-style-type: none"> • 1year • Stockpile I • Stockpile II | 3120 |
| | Firmware Compatibility faults (during device service only) | 1480 |
| | Serial Number Compatibility faults (during device service only) | 3480 |
| | RTC Battery Low (Checked at start up) | 3110 |
| | Power Cycle Needed | 3121 |

Note: It is possible that an internal communication failure may due to a software condition rather than a hardware failure. When this occurs the alarm may be cleared with a power cycle (turn the device OFF and then back ON). If the condition persists then the device should be returned to service.

Managing Alarms

Alarms are indicated both audibly (through the buzzer and visually through the LED array (red, yellow), and in the LCD with alarm bell icons, title, and Service Code (SC). As indicated above, each alarm is also indicated with Smart Help in the AMC which provide several steps to resolve or mitigate the alarm. The AMC also contains “If Not Resolved” instructions which are at the end of the AMC and surrounded by asterisk. These contain instructions on how to manage the patient if the Mitigation/Resolution Instructions and user actions do not resolve the alarm. The example below shows an “If Not Resolved” instruction.

****Contact Service Center****

Based on the types of alarms (Patient Safety, Environmental and Use, and Self Check) and their effect on the patient and/or device (high, medium, low) alarms are prioritized and presented to the user in the order that most effects the patient. In this way, the user is prompted to address the issue or issues that most effect the safety of the patient. This grouping is to provide a framework to identify the alarm conditions.

The AMC accommodates the display of up to 5 active alarms. The alarms are displayed in order of priority and rank. Only the highest priority alarm or set of alarms are displayed at one time. For example, if three medium and one high priority alarms are present in the system only the high priority alarm will be displayed until it is resolved. The medium priority alarms will then be displayed if they are still present in the system. In addition to the priority, each alarm is ranked according to the severity of risk to the patient. Only the five highest ranked alarms will be displayed on the screen. If six or more alarms are present in the system, the lowest rank and priority will not be displayed in the AMC. Additionally, only alarms that are set and displayed in the system can be reviewed in the Alarm History Menu. Lower priority and rank alarms that resolve before the displayed higher alarms will not be logged in the Alarm History Menu. See Chapter 4 for instructions on viewing the Alarm History Menu.

When there are multiple alarms, you can control which alarm is displayed by selecting its associated icon. If the alarms are Low Priority, then the Pleth and Pressure/Time plots appear permanently on the screen when the alarms are muted. If the alarms are Medium Priority, the ventilator cycles through each Medium Priority Alarm every 20 seconds. You can use the selection dial to select a particular Medium Priority Alarm and/or Plot for 20 seconds, after which, cycling resumes. New alarms can overwrite the screen at any time based on their priority.

Alarm Muting

Start Up Muting

At start up, the ventilator suspends active patient safety alarms, with the exception of those alarms that could affect the performance of the device. This prevents nuisance alarms during start up while you configure the ventilator. When the Start Menu is used, the 2-minute countdown starts once you select a start option. Once the patient is connected, the mute cancels automatically after 15 seconds when there are no active alarms.

Note: When the Start Menu is not used as the powerup option, the 120 seconds mute begins immediately following the Self Check and cancels as described above.

Preemptive Muting

To prevent excessive noise in the patient care environment, alarms shown below can be preemptively muted for 30 seconds. This enables you to prevent the audible alarm, by pressing the Mute button, before initiating a procedure that could trigger an alarm.

Note: During this preemptive mute of this audible alarm, the LED alarm light and alarm message are still indicated.

| Service Code | Alarm Name |
|--------------|---|
| 2062 | Exhalation System Fault |
| 2070 | Airway Pressure High |
| 2071 | Low Airway Pressure |
| 2072 | High Tidal Volume |
| 2073 | Low Tidal Volume |
| 2074 | High Breath Rate |
| 2075 | Low Breath Rate/Apnea |
| 2076 | Apnea |
| 2090 | PEEP Leak |
| 2095 | Insufficient Flow |
| 2100 | Patient Disconnect |
| 2170 | Spont. Breath PIP High |
| 2171 | Spont. Breath PIP Low |
| 2172 | Spont. Breath-V _T High |
| 2173 | Spont. Breath-V _T Low |
| 2300 | Self Check Fault (Pulse Ox Module Failed) |
| 2301 | Self Check Fault (Internal COMM: Pulse Ox Module) |
| 2314 | Pulse Ox Sensor Off Patient |
| 2401 | SpO ₂ Low |
| 2410 | Heart Rate High |
| 2411 | Heart Rate Low |
| 3300 | Self Check Fault (Pulse Ox Module Not Available, SpO ₂ /HR Not Available (MS2011SB Failure-Monitor Not In Use) |
| 3301 | Self Check Fault (Pulse Ox Module Not Available, SpO ₂ /HR Not Available (Pulse Ox Module Failure, SpO ₂ /HR Not Available) |
| 3310 | Pulse Ox Sensor Not Connected |
| 3311 | Defective Pulse Ox Sensor |
| 3312 | Pulse Search |
| 3313 | Pulse Ox Signal Interference (External Signal Interfering With Measurement) |
| 3315 | Ambient Light Fault |
| 3316 | Invalid Pulse Ox Sensor |
| 3317 | Low SpO ₂ Perfusion |
| 3318 | Low SpO ₂ Perfusion |

Disabling Alarms from the Alarm Configuration Menu

There are clinical situations where an alarm occurs, and in the user's clinical judgment, this alarm is a nuisance that does not affect the safe management of the patient.

The ventilator allows a series of alarms to be disabled for the duration of the current use. These alarms are listed in the following table:

| Alarm Name | Service Code | Constraints |
|--------------------|--------------|--|
| Auto PEEP | 3091 | To avoid nuisance alarms, the Auto-PEEP alarm is disabled at start up. The user can choose to activate the alarm if they believe the patient is at risk of Auto-PEEP. |
| PEEP Leak | 2090 | Alarms that have occurred in the current operating session can be canceled. |
| PM Due | 3120 | |
| RTC Battery Low | 3110 | |
| Inspiratory Demand | 3092 | |
| Intake Restricted | 3031 | |

To disable an alarm, press the Menu button and use the Dial to scroll to the alarm configuration menu. Press the Accept button. Then scroll down to the alarm that is to be disabled using the Dial and press the Accept. Use the Dial to select off, and then press the Accept to complete the change.

- Alarms that have occurred in the current operating session can be canceled.
- Alarms which have not occurred since turn on are indicated with a "--".
- Disabled alarms are not be saved in the User Settings for the next session.
- All disabled alarms reappear (if appropriate) when the ventilator is next used. (As an example, the Self Check Fault (Calibration Due) (SC: 3480), reappears in the next operating session.)

Note: To avoid nuisance alarms, the Auto-PEEP alarm (SC: 3091) is disabled at start up. The user can choose to activate the alarm if they believe the patient is at risk of Auto-PEEP.

Patient Detect Mode

When powering on the device with the Start Menu, the device has a Patient Detected (PD) alarm to detect if a patient connected to the device is in a non-ventilating state. The device detects pressure changes which reflect the following conditions:

- Infant through adult patients with no inspiratory effort
- Infant through adult patients with active inspiratory effort
- Infant through adults with patient circuits connected to masks.

In the event a patient is detected before a Start Menu option is made, a medium priority alarm is displayed to indicate that a patient is connected to a non-ventilating device.

While in PD mode, low and medium priority alarms mute behavior is maintained. Triggered low and medium priority alarms will display. When muted or resolved the start menu will display again. PD mode has no affect on high priority alarms.

The device immediately starts ventilating with the setting described in the table below:

Note: When the Patient Detect alarm is active the Mode Parameter window displays "---". This is done to encourage the user to configure the ventilator appropriately for the patient.

While in PD Mode, Battery and Power, Environmental, and Self check alarms are detected and displayed when present in the device. Only the following selected patient safety alarm conditions are detected:

- SC: 2110 - Patient Detected
- SC: 2062 - Exhalation System Fault
- SC: 1060 - Exhalation System Failure
- SC: 1061 - Exhalation System Failure

Backup Modes

In the event of certain internal system failures, a backup mode takes control to continue ventilating and alerts the user with audible and visual alarms. While in backup mode the device continues to ventilate with the currents settings that were in use before the failure. Changes to the device settings are not possible. The backup mode is activated with all internal COMM failure alarms. (SC: 1173,1471, 1472, 1474, and 1475)

While in backup mode, if any of the following conditions are detected for three consecutive breaths, the device will switch to a pressure targeted configuration, see table below, to continue support of the patient and prevent excessive airway pressure:

- Airway Pressure High (SC: 2070)
- Patient Disconnect (SC: 2100)
- Auto-PEEP (SC: 3091)

Note: Since the priority of these conditions are lower priority than the initial failure causing backup mode, these alarms will not be visible in the AMC.

The Mitigation/Resolution Instructions for the individual alarms should be followed to manage the patient and device if Backup is active.

Apnea Backup Mode

Apnea Backup is activated when the Apnea alarm (SC: 2076) is triggered during CPAP or BL mode. The alarm triggers when the spontaneous breathing rate is less than the BPM Low Limit setting. Apnea Backup settings should be configured for the individual patient's needs. This is done in the Mode context menu when either CPAP or BL is the mode. Chapter 4 contains detailed information on editing the Mode context menu along with the default settings and setting ranges.

Additionally, the Manual Breath button delivers a single breath when pressed, using the current Apnea Backup settings for a mandatory breath in CPAP and BL modes.

| | Backup | Apnea | PD Mode |
|------------------|------------------------------|---------|------------------------------|
| | AC(P) | SIMV(P) | AC(P) |
| BPM | 12 | 12 | 14 |
| I:E | 1:4 | 1:3 | 1:3 |
| PIP | 20 | 20 | 20 |
| PEEP | 5 | As Set | 5 |
| Rise Time | 5 | As Set | 6 |
| PIP High | 25 | As Set | 25 |
| PIP Low | 3 | As Set | 10 |
| Vt High | 700 | As Set | 750 |
| Vt Low | | As Set | 250 |
| FIO ₂ | As Set | As Set | 21 |
| Trigger | -2 cm H ₂ O (hPa) | As Set | -2 cm H ₂ O (hPa) |

Alarm Summary

A list of all ventilator alarms follows and is divided into three categories:

- High Priority
- Medium Priority
- Low Priority

Alarms in each list are provided in numerical order based on their Service Code.

High Priority Alarms

| Service Code | Alarm Name | Description / Mitigation/Resolution / If Not Resolved Instructions |
|--------------|--------------------|---|
| 1001 | Self Check Failure | <p>Description: Alarm triggers when the compressor fails to operate or fails to provide the flow required to deliver a breath and high pressure O₂ is not available to provide ventilation.</p> <p>Mitigation/ Resolution: <i>Pneumatic System: Compressor, Manually Ventilate Patient, Connect 55 psig/380 kPa O₂, Restart Ventilator with O₂,</i></p> <p>If Not Resolved: <i>**Contact Service Center**</i></p> |

| Service Code | Alarm Name | Description / Mitigation/Resolution / If Not Resolved Instructions |
|--------------|-----------------------------------|--|
| 1002 | Self Check Failure | <p>Description: Alarm triggers when communication between the compressor controller and Smart Pneumatic Module (SPM) is lost and high pressure O₂ is not available to provide ventilation.</p> <p>Mitigation/ Resolution: <i>Pneumatic System: Compressor, Manually Ventilate Patient, Connect 55 psig/380 kPa O₂, Restart Ventilator with O₂,</i></p> <p>If Not Resolved: **Contact Service Center**</p> |
| 1003 | Self Check Failure | <p>Description: Alarm triggers when the flow from the first breath is $\pm 20\%$ of the expected flow for the tidal volume at start up. This unusually low RPM is a symptom of a dirty flow screen which cannot be serviced by the user.</p> <p>Mitigation/ Resolution: <i>Pneumatic Sensor: Pneumotach, Manually Ventilate Patient,</i></p> <p>If Not Resolved: **Contact Service Center**</p> |
| 1010 | Self Check Failure | <p>Description: Alarm triggers when the O₂ valve fails in the open position which results in continuous inspiratory flow. When this occurs the device automatically opens the exhalation valve to prevent pressure from accumulating in the circuit and ventilation stops.</p> <p>Mitigation/ Resolution: <i>Pneumatic System: O₂ Valve, Manually Ventilate Patient,</i></p> <p>If Not Resolved: **Contact Service Center**</p> |
| 1011 | Self Check Failure | <p>Description: Alarm occurs when the signal to the O₂ valve is not delivering the required flow rate and the compressor is not available to provide ventilation.</p> <p>Mitigation/ Resolution: <i>Pneumatic System: O₂ Valve, Manually Ventilate Patient,</i></p> <p>If Not Resolved: **Contact Service Center**</p> |
| 1012 | Self Check Failure | <p>Description: Alarm occurs when the communication between the O₂ valve and the SPM fails and the compressor is not available to provide ventilation.</p> <p>Mitigation/ Resolution: <i>Pneumatic System: O₂ Valve, Manually Ventilate Patient,</i></p> <p>If Not Resolved: **Contact Service Center**</p> |
| 1020 | Low O ₂ Supply Failure | <p>Description: Alarm occurs when the O₂ supply pressure is < 35 psig (241 kPa) and the compressor is not available to support ventilation. If the O₂ source can be restored the device should be cycled off then on to reset. By design the device will not reestablish O₂ operation unless the supply pressure is ≥ 40 psig (276 kPa). If the supply pressure is between 40 and 87 psig (276 to 600 kPa) the user should check the hose connections for leaks. Occasionally, this alarm can be caused by a regulator that provides a static pressure within range but is not able to provide the flow necessary to meet the patient flow demand.</p> <p>Mitigation/ Resolution: <i>Manually Ventilate Patient, Connect 55 psig/380 kPa O₂, Restart, Check O₂ Supply for Leaks, Replace Regulator,</i></p> <p>If Not Resolved: **Contact Service Center**</p> |

| Service Code | Alarm Name | Description / Mitigation/Resolution / If Not Resolved Instructions |
|--------------|------------------------------------|---|
| 1030 | Gas Intake Failure | <p>Description: Alarm occurs when the Fresh Gas/Emergency Air Inlet is blocked so that the compressor is not able to deliver flow sufficient for the current settings and high pressure O₂ is not available to support ventilation. The user should clear the blockage and restart the ventilator. A false alarm can be triggered in very high vibration environments.</p> <p>Mitigation/ Resolution: <i>Manually Ventilate Patient, Clear Blocked Intake, Connect 55 psig/380 kPa O₂, Restart Ventilator</i></p> <p>If Not Resolved: <i>**Contact Service Center**</i></p> |
| 1041 | High O ₂ Supply Failure | <p>Description: Alarm triggers when the O₂ supply pressure is > 87 psig (600 kPa). Pressures above 87 psig (600 kPa) can result in a failure, harm to the patient and/or damage to the device. While the patient is manually ventilated the user or assistant should seek to reduce the O₂ supply pressure. Sometimes this requires changing the regulator which is not functioning as required. If the pressure cannot be reduced and a low flow device like a flow meter is available the user can provide supplemental O₂ via the optional low flow O₂ reservoir. To clear the alarm the device should be turned off and then restarted with supply pressure in the appropriate range (40 to 87 psig, 276 to 600 kPa) or without the high pressure O₂ source connected.</p> <p>Mitigation/ Resolution: <i>Manually Ventilate Patient, Decrease O₂ to 55 psig/380 kPa, Replace Regulator, Connect Low Flow O₂, Restart</i></p> <p>If Not Resolved: <i>**Contact Service Center**</i></p> |
| 1051 | Self Check Failure | <p>Description: Alarm triggers when the autocal procedure is not able to zero the airway pressure transducer to ambient pressure. When this occurs, manually ventilate the patient, replace the ventilator and contact the service center for additional information. Note: a false alarm can be triggered during operation in very high vibration environments when the device is not mounted correctly. If this could be the cause, restart the ventilator and continue operation if no alarms are triggered.</p> <p>Mitigation/ Resolution: <i>Pneumatic Sensor: Autocal, Manually Ventilate Patient</i></p> <p>If Not Resolved: <i>**Contact Service Center**</i></p> |
| 1052 | Self Check Failure | <p>Communication between the airway pressure sensor and SPM is lost. When this happens, manually ventilate the patient, replace the ventilator and contact the service center for additional information.</p> <p>Mitigation/ Resolution: <i>Pneumatic Sensor: Airway Pressure, Manually Ventilate Patient</i></p> <p>If Not Resolved: <i>**Contact Service Center**</i></p> |

| Service Code | Alarm Name | Description / Mitigation/Resolution / If Not Resolved Instructions |
|--------------|---------------------------|---|
| 1060 | Exhalation System Failure | <p>Description: Alarm occurs when the PIP fails to return to the baseline pressure for 3 consecutive breaths, indicating that the exhalation control valve has failed. When triggered, the device stops ventilating and attempts to discharge the pressure in the breathing circuit to atmosphere. This failure may be caused by a significant blockage of the exhalation valve or an occlusion/kink in the exhalation valve tube. If possible, the user should replace the breathing circuit and restart the ventilator. If this does not resolve the failure, replace the ventilator and contact the service center for additional information.</p> <p>Mitigation/ Resolution: <i>Patient Can Not Exhale, Manually Ventilate Patient, Check for Kinked Hose/Tube, Replace Circuit and Restart</i></p> <p>If Not Resolved: **Contact Service Center**</p> |
| 1061 | Exhalation System Failure | <p>The airway pressure, PIP, is > 40 cm H₂O (hPa), the PIP High Limit (when PIP High Limit is < 35 cm H₂O (hPa)) for > 5 seconds, or when the PIP is > 75 cm H₂O (hPa) for > 1.5 seconds. When this happens, the device stops ventilating and attempts to discharge the pressure in the breathing circuit to atmosphere. This failure may be caused by a significant blockage of the exhalation valve or an occlusion/kink in the exhalation valve tube. If possible, the user should replace the breathing circuit and restart the ventilator. If this does not resolve the problem, replace the ventilator and contact the service center for additional information.</p> <p>Mitigation/ Resolution: <i>Patient Can Not Exhale, Manually Ventilate Patient, Check for Kinked Hose/Tube, Replace Circuit and Restart</i></p> <p>If Not Resolved: **Contact Service Center**</p> |
| 1172 | Self Check Failure | <p>Description: Alarm occurs when the 5 VDC power bus fails to provide the required voltage. If this failure occurs, the user should manually ventilate the patient, replace the ventilator and contact the service center for additional information.</p> <p>Mitigation/ Resolution: <i>Pneumatic Sensor: Autocal, Manually Ventilate Patient</i></p> <p>If Not Resolved: **Contact Service Center**</p> |
| 1173 | Self Check Failure | <p>Description: Alarm occurs when communication fails between one of the subcomponents and the host processor. If this failure occurs, remove (disconnect) the external power supply, turn OFF the ventilator, then turn it back ON (providing time to allow the ventilator to rest). If the ventilator starts with a Self-Check failure, or if the alarm continues, then the user should manually ventilate the patient, replace the ventilator and contact the service center for additional information.</p> <p>Mitigation/ Resolution: <i>Internal COMM, Manually Ventilate Patient, Backup Ventilator Started</i></p> <p>If Not Resolved: **Contact Service Center**</p> |

| Service Code | Alarm Name | Description / Mitigation/Resolution / If Not Resolved Instructions |
|--------------|---------------------------------------|---|
| 1174 | Self Check Failure | <p>Description: Alarm occurs when the device is not able to calibrate one or more transducers and is no longer able to operate safely. If this failure occurs, the user should manually ventilate the patient, replace the ventilator, and contact the service center for additional information.</p> <p>Mitigation/ Resolution: <i>Pneumatic Sensor: Transducer, Manually Ventilate Patient, Restart Ventilator</i></p> <p>If Not Resolved: **Contact Service Center**</p> |
| 1175 | Self Check Failure | <p>Description: Alarm triggers when the internal communication bus and the host are not able to communicate with the subassemblies. If this failure occurs, remove (disconnect) the external power supply, turn OFF the ventilator, then turn it back ON (providing time to allow the ventilator to rest). If the ventilator starts with a Self-Check failure, or if the alarm continues, then the user should manually ventilate the patient, replace the ventilator and contact the service center for additional information.</p> <p>Mitigation/ Resolution: <i>Internal COMM, Manually Ventilate Patient</i></p> <p>If Not Resolved: **Contact Service Center**</p> |
| 1176 | Self Check Failure | <p>Description: Alarm triggers when the calibration file fails its integrity check. The user should manually ventilate the patient, replace the ventilator and contact the service center for additional information.</p> <p>Mitigation/ Resolution: <i>Internal COMM, Manually Ventilate Patient</i></p> <p>If Not Resolved: **Contact Service Center**</p> |
| 1420 | Self Check: Complete Power Failure | <p>Description: Alarm triggers when power is lost from both the internal battery and an external source during operation. When this occurs, the LCD blanks (no power for operation), the audible alarm pulses rapidly, and the visual alarm flashes rapidly. This alarm will last approximately two minutes. If the device can be recharged after the failure and there are no other issues it can be returned to service. If there are any questions, contact the service center for additional information. See the section titled, "Complete Power Failure", earlier in this chapter.</p> <p>Mitigation/ Resolution: <i>No LCD Display</i></p> |
| 1430 | Drained Battery | <p>Description: Alarm triggers when the internal battery power drops below the amount required to provide ventilation and external power is not connected. When this occurs there is enough power to operate the user interface and provide information to the user. The user should be manually ventilate the patient while an external source of power is sought. To cancel the alarm and begin operation with external power the device must be turned off and then back on.</p> <p>Mitigation/ Resolution: <i>Manually Ventilate Patient, Connect External Power</i></p> <p>If Not Resolved: **Contact Service Center**</p> |

| Service Code | Alarm Name | Description / Mitigation/Resolution / If Not Resolved Instructions |
|--------------|--------------------|---|
| 1471 | Self Check Failure | <p>Description: Alarm triggers when the device is no longer able to communicate with the User Interface Module (UIM) and the interface controls. When this occurs ventilation continues at the current settings or the backup mode settings and the high priority alarm sounds. When this failure occurs, remove (disconnect) the external power supply, turn OFF the ventilator, then turn it back ON (providing time to allow the ventilator to rest). If the ventilator starts with a Self-Check failure, or if the alarm continues, then the user should manually ventilate the patient, replace the ventilator and contact the service center for additional information.</p> <p>Mitigation/ Resolution: <i>Internal COMM, Manually Ventilate Patient</i></p> <p>If Not Resolved: <i>**Contact Service Center**</i></p> |
| 1472 | Self Check Failure | <p>Description: Alarm triggers when the device is no longer able to communicate with the Smart Pneumatic Module (SPM). When this occurs ventilation continues at the current settings or the backup mode settings and the high priority alarm sounds. The user should manually ventilate the patient, replace the ventilator and contact the service center for additional information.</p> <p>Mitigation/ Resolution: <i>Internal COMM, Manually Ventilate Patient</i></p> <p>If Not Resolved: <i>**Contact Service Center**</i></p> |
| 1474 | Self Check Failure | <p>Description: Alarm triggers when cyclic redundancy checking between the device and SPM fails. When this occurs ventilation continues at the current setting or the backup mode settings and the high priority alarm sounds. The user should manually ventilate the patient, replace the ventilator and contact the service center for additional information.</p> <p>Mitigation/Infor: <i>Internal COMM, Manually Ventilate Patient</i></p> <p>If Not Resolved: <i>**Contact Service Center**</i></p> |
| 1475 | Self Check Failure | <p>Description: Alarm triggers when the device has lost communication with the contrast control and in most instances the content of the LCD is not visible. When this occurs ventilation continues at the current settings or the backup mode setting and the high priority alarm sounds. The user should manually ventilate the patient, replace the ventilator and contact the service center for additional information.</p> <p>Mitigation/ Resolution: <i>Internal COMM, Manually Ventilate Patient, Backup Ventilator Started</i></p> <p>If Not Resolved: <i>**Contact Service Center**</i></p> |
| 1480 | Self Check Failure | <p>Description: Alarm triggers when the device and SPM software loads are not compatible. This alarm is typically associated with an SPM change where the technician failed to update the device and SPM to the current software revision. Ventilation is provided using the backup mode settings. The user should manually ventilate the patient, replace the ventilator and contact the service center for additional information.</p> <p>Mitigation/ Resolution: <i>Firmware Mismatch, Manually Ventilate Patient, Software Compatibility Failure</i></p> <p>If Not Resolved: <i>**Contact Service Center**</i></p> |

Medium Priority Alarms

| Service Code | Alarm Name | Mitigation/Resolution |
|--------------|------------------|--|
| 2001 | Self Check Fault | <p>Description: Alarm triggers when the communication between the compressor and the SPM fails and high pressure O₂ is available to provide ventilation. The alarm will continue to sound as a medium priority alarm until the user acknowledges that ventilation is being provided using O₂ by setting the FIO₂ to 100%. At this time the priority changes to low priority. While operating in this state the user should ensure an adequate supply of O₂. Failure to maintain the O₂ supply will result in a high priority alarm.</p> <p>Mitigation/ Resolution: <i>Pneumatic System: Compressor, Operation Switched to O₂ Supply, Set FIO₂ to 100%, Monitor O₂ Supply</i></p> <p>If Not Resolved: <i>**Contact Service Center**</i></p> |
| 2002 | Self Check Fault | <p>Description: Alarm triggers when the communication between the O₂ valve and the SPM fails and the compressor is available to provide ventilation. The alarm will continue to sound as a medium priority alarm until the user acknowledges that ventilation is being provided using the compressor by setting the FIO₂ to 21%. At this time the alarm priority changes to low. While operating in this state the user should monitor the SpO₂ to ensure that adequate oxygenation is maintained. If low flow O₂ is available it can be entrained through the Fresh Gas/ Emergency Air Intake port using the optional O₂ reservoir. Maintain an acceptable SpO₂ by adjusting the O₂ supply up or down to increase or decrease the amount of O₂ delivered to the patient.</p> <p>Mitigation/ Resolution: <i>Pneumatic System: Compressor, Operation Switched to O₂ Supply, Set FIO₂ to 100%, Monitor O₂ Supply</i></p> <p>If Not Resolved: <i>**Contact Service Center**</i></p> |
| 2011 | Self Check Fault | <p>Description: Alarm triggers when the signal to the O₂ valve is outside of the calibration range for the required flow rate and the compressor is available to provide ventilation. The medium priority alarm will continue until the user acknowledges that ventilation is being provided using the compressor by setting the FIO₂ to 21%. At this time the alarm priority changes to low priority. While operating in this state the user should monitor the SpO₂ to ensure that adequate oxygenation is maintained. If low flow O₂ is available it can be entrained through the Fresh Gas/Emergency Air Intake port using the optional O₂ reservoir. Maintain an acceptable SpO₂ by adjusting the O₂ supply up or down to increase or decrease the amount of O₂ delivered to the patient.</p> <p>Mitigation/ Resolution: <i>Pneumatic System: O₂ Valve, Operation Switched to Compressor, Connect Low Flow O₂, Monitor SpO₂</i></p> <p>If Not Resolved: <i>**Contact Service Center**</i></p> |

| Service Code | Alarm Name | Mitigation/Resolution |
|--------------|---------------------------------|--|
| 2012 | Self Check Fault | <p>Description: Alarm triggers when the communication between the O₂ valve and the SPM fails and the compressor is available to provide ventilation. The alarm will continue to sound as a medium priority alarm until the user acknowledges that ventilation is being provided using the compressor by setting the FIO₂ to 21%. At this time the alarm priority changes to low. While operating in this state the user should monitor the SpO₂ to ensure that adequate oxygenation is maintained. If low flow O₂ is available it can be entrained through the Fresh Gas/Emergency Air Intake port using the optional O₂ reservoir. Maintain an acceptable SpO₂ by adjusting the O₂ supply up or down to increase or decrease the amount of O₂ delivered to the patient.</p> <p>Mitigation/ Resolution: <i>Pneumatic System O2 Valve, Set FIO2 To 21%, Connect Low Flow O2, Monitor SpO2</i></p> <p>If Not Resolved: <i>**Contact Service Center**</i></p> |
| 2020 | Low O ₂ Supply Fault | <p>Description: Alarm triggers when the O₂ supply pressure is < 35 psig (241 kPa) and the compressor is able to support ventilation. When this occurs the device begins ventilation using the compressor. The alarm will continue to sound as a medium priority alarm until the user acknowledges that ventilation is being provided using the compressor by setting the FIO₂ to 21%. The alarm will cancel completely when the user sets FIO₂ to 21%.</p> <p>Note: The device works with or without external O₂. If O₂ is connected the device will restart O₂ operation unless the supply pressure is ≥ 40 psig (276 kPa). This is done to prevent continuous cycling between alarms during the inspiratory phase and no alarm during the expiratory phases. If low flow O₂ is available it can be entrained through the Fresh Gas/Emergency Air Intake port using the optional O₂ reservoir. Maintain an acceptable SpO₂ by adjusting the O₂ supply up or down to increase or decrease the amount of O₂ delivered to the patient.</p> <p>Mitigation/ Resolution: <i>Operation Switched to Compressor, Check O2 Supply Pressure, Check/Replace Regulator, Set FIO2 to 21%. Connect Low Flow O2, Monitor SpO2</i></p> <p>If Not Resolved: <i>**Contact Service Center**</i></p> |
| 2030 | Gas Intake Fault | <p>Description: Alarm triggers when the Fresh Gas/Emergency Air Inlet is blocked so that the compressor is not able to deliver a breath within ±10% of the current settings and high pressure O₂ is available to support ventilation. When this occurs the ventilator immediately switches to O₂ powered ventilation. To clear the alarm first set the FIO₂ to 100% to acknowledge that the patient is being ventilated at 100%, clear the blockage and then set the FIO₂ back to the original value. Once the blockage has been cleared operation with the compressor will restart. If the blockage cannot be cleared, the alarm will resound, continue ventilation with FIO₂ set to 100% and ensure an adequate supply of O₂. NOTE: A high vibration environment can trigger this alarm. If necessary, the user can activate the O₂ Reservoir mode while continuing to operate normally. This will suppress the alarm.</p> <p>Mitigation/ Resolution: <i>Operation Switched to O2 Supply, Clear Blocked Intake, Set FIO2 to 100%, Monitor SpO2, Monitor O2</i></p> <p>If Not Resolved: <i>**Contact Service Center**</i></p> |

| Service Code | Alarm Name | Mitigation/Resolution |
|--------------|-------------------------|--|
| 2053 | Self Check Fault | <p>Description: Alarm triggers when the expiratory time is < 170 ms for 3 consecutive breaths. When this occurs the device attempts to reestablish a baseline by momentarily setting PEEP to 0 cm H₂O (hPa) and suspending triggered breaths. This interruption lasts no longer than 2 breath cycles. The user should also check for leaks in the hose and tubes, patient airway and exhalation valve. If recalibration is successful the alarm will automatically cancel. If the device does not reset, manually ventilated the patient, replace the ventilator and contact the service center for additional information.</p> <p>Mitigation/ Resolution: <i>Pneumatic Sensor: Airway Pressure, Check Circuit for Leaks/Disconnects, Check Tube Placement/Cuff</i></p> <p>If Not Resolved: <i>**Contact Service Center**</i></p> |
| 2062 | Exhalation System Fault | <p>Description: Alarm triggers when the airway pressure, PIP, measured at the end of expiration is > 5 cm H₂O (hPa) above the baseline pressure, PEEP. This is typically caused by a restriction of the exhalation valve or an occlusion/kink in one or more of the breathing circuit tubes or hose. If the breathing circuit tubes appear to be intact the circuit should be replaced to eliminate the possibility of a bad exhalation valve. If the condition does not resolve the user should manually ventilate the patient, replace the ventilator and contact the service center for additional information.</p> <p>Mitigation/ Resolution: <i>Check Patient Exhalation, Check Circuit for Kinked Hose/Tube, Check for Blocked Exhalation Valve, Replace Circuit, Replace/Service Ventilator</i></p> <p>If Not Resolved: <i>**Manually Ventilate Patient**</i></p> |
| 2070 | Airway Pressure High | <p>Description: Alarm triggers when the airway pressure, PIP, is > the high airway pressure limit for 2 consecutive breaths. When the limit is reached, the flow decelerates to keep the PIP below the airway pressure for the duration of the breath (inspiratory time). The user should check for kinks or blockage of the breathing circuit, exhalation valve or patient airway. In some instances the cause can be an accumulation of secretions in the airway which will require suctioning to clear. The user should also assess if the patient is fighting the ventilator, asynchrony, or if the high airway pressure limit is set too low.</p> <p>Mitigation/ Resolution: <i>Pressure Exceeds Limit Setting, Check Circuit for Kinked Hose/Tube, Check for Airway Obstruction, Suction Airway if Necessary, Check High PIP Limit Setting</i></p> <p>If Not Resolved: <i>**Manually Ventilate Patient**</i></p> |
| 2071 | Low Airway Pressure | <p>Description: Alarm triggers when the airway pressure, PIP, is < the low airway pressure limit for 2 consecutive breaths. The user should check for leaks/disconnects in the breathing circuit, patient airway or a failure of the exhalation valve. The user should also assess if the patient is breathing with the ventilator, the PIP or tidal volume are set too low, or if the low airway pressure limit is set too high. If a replacement is available, the user should replace the breathing circuit. If these mitigations do not resolve the alarm condition, replace the ventilator and contact the service center for more information.</p> <p>Mitigation/ Resolution: <i>Check Patient Connection, Check Circuit For Loose Hose/Tube, Check Exhalation Valve, Check Tube Placement/Cuff, Check Low Limit Setting</i></p> <p>If Not Resolved: <i>**Manually Ventilate Patient**</i></p> |

| Service Code | Alarm Name | Mitigation/Resolution |
|--------------|-------------------|---|
| 2072 | High Tidal Volume | <p>Description: Alarm triggers during pressure targeted ventilation when the delivered tidal volume exceeds the user defined limit for 2 consecutive breaths. This can be caused by a leak in the patient connection or breathing circuit. When the ventilator is not able to reach the pressure target flow increases to compensate which leads to a high delivered tidal volume. It is critical to set this alarm with infant and pediatric patients given that the high resistance airways used with these patients can provide a false airway pressure even when the patient has extubated or decannulated. The user should check for leaks/disconnects in the breathing circuit, patient airway or a failure of the exhalation valve. Users should also assess if the patient is anxious and breathing deeply or if the high tidal volume limit is set too low. If a replacement is available the user should replace the breathing circuit.</p> <p>Mitigation/ Resolution: <i>Check Patient Connection, Check Circuit For Loose Hose/Tube, Check Exhalation Valve, Check Tube Placement/ Cuff, Check High Limit Setting</i></p> <p>If Not Resolved: <i>**Monitor Patient**</i></p> |
| 2073 | Low Tidal Volume | <p>Description: Alarm triggers during pressure targeted ventilation when the delivered tidal volume does not reach the user defined limit for 2 consecutive breaths. When this occurs flow decelerates to maintain the airway pressure at airway pressure limit for the duration of the breath (inspiratory time). If the PIP setting is set properly the breath should be greater than the low limit, provided it is set correctly. The user should check for kinks or blockage of the breathing circuit or patient airway. In some instances the cause can be an accumulation of secretions in the airway which will require suctioning to clear. The user should also assess if the patient is fighting the ventilator, asynchrony, or if the PIP target is set too low.</p> <p>Mitigation/ Resolution: <i>Check Circuit For Kinked Hose/Tube, Check For Airway Obstruction, Suction Airway If Necessary, Check Low Limit Setting,</i></p> <p>If Not Resolved: <i>**Manually Ventilate Patient**</i></p> |
| 2074 | High Breath Rate | <p>Description: Alarm triggers when the actual breathing rate (set rate plus spontaneous patient rate) exceeds the high alarm limit. This can be caused by the patient breathing too fast due to anxiety or pending respiratory failure. It can also be caused by autotriggering due to a leak or the when the spontaneous/assisted breath trigger is set too close to the baseline pressure, PEEP. The user should check for leaks/disconnects in the breathing circuit, patient airway or a failure of the exhalation valve. The user should also assess if the patient is anxious and breathing deeply or if the high tidal volume limit is set too low. If a replacement is available the user should replace the breathing circuit.</p> <p>Mitigation/ Resolution: <i>Check For Loose Circuit Connection, Check Trigger Setting, Check High Alarm Limit Setting</i></p> <p>If Not Resolved: <i>**Consult Physician**</i></p> |

| Service Code | Alarm Name | Mitigation/Resolution |
|--------------|---------------------------|--|
| 2075 | Low Breath Rate/ Apnea | <p>Description: Alarm triggers when the actual breathing rate (set rate plus spontaneous patient rate) is less than the low alarm limit. This can be caused by the patient not breathing or breathing at a rate less than the limit. If the spontaneous/assisted breath trigger is not sensitive enough the patient may not be able to trigger breaths. The user should also determine if the low rate is set too high for the patient.</p> <p>Mitigation/ Resolution: <i>Check Patient for Spontaneous Breathing, Adjust Breath Trigger, Check Low Alarm Limit Setting, Increase Ventilation Support</i></p> <p>If Not Resolved: <i>**Manually Ventilate Patient**</i></p> |
| 2076 | Apnea | <p>Description: Alarm triggers when the spontaneous breathing rate is less than the low alarm limit. This alarm only occurs in noninvasive ventilation, CPAP and BL modes. The alarm can be caused by the patient not breathing or breathing at a rate less than the limit. The apnea backup ventilation starts automatically when the alarm is triggered. The user should select an active mode of ventilation, AC or SIMV, to support the patient.</p> <p>Mitigation/ Resolution: <i>Apnea Backup Ventilation Started, Set Mode to AC or SIMV, Set Rate and Tidal Volume/Pressure Target</i></p> <p>If Not Resolved: <i>**Manually Ventilate Patient**</i></p> |
| 2090 | PEEP Leak | <p>Description: Alarm triggers when the airway pressure drops below the PEEP setting by 2 cm H₂O (hPa) during the expiratory phase of the breath. This can be caused by a leak in the breathing circuit, exhalation valve or patient airway. The user should check the breathing circuit and exhalation valve to ensure that all connections are tight. If the circuit appears damaged or is suspect it should be replaced. The user should also check if there is a cuff leak from the patient's airway or mask. If these mitigations do not resolve the alarm the user can choose to use leak compensation to provide additional flow during the expiratory phase to compensate for the leak. If you still cannot compensate for the leak, consult the attending physician. If this fails replace the ventilator and contact the service center for more information.</p> <p>Mitigation/ Resolution: <i>Check Patient Connection, Check for Loose Circuit Connection, Check Exhalation Valve, Check Tube Placement/ Cuff, Disable Alarm</i></p> <p>If Not Resolved: <i>**Replace Circuit**</i></p> |
| 2095 | Insufficient Flow | <p>Description: Alarm triggers when the pressure target is not reached during the inspiratory period during pressure targeted ventilation. Typically this can occur when the Rise Time is set too low for the patient and their respiratory mechanics. Decrease the Rise Time and check the circuit and exhalation valve for leaks or disconnects. If the flow cannot be adjusted appropriately then the patient should be ventilated using volume targeted ventilation.</p> <p>Mitigation/ Resolution: <i>Pressure Target Not Met, Decrease Rise Time, Press/Hold BPM Button, Consult Physician</i></p> <p>If Not Resolved: <i>**Ventilate With Volume Target**</i></p> |

| Service Code | Alarm Name | Mitigation/Resolution |
|--------------|------------------------|--|
| 2100 | Patient Disconnect | <p>Description: Alarm triggers when the airway pressure fails to exceed the PEEP setting by ~ 7 cm H₂O (hPa) When this occurs the user should check the patient connection, breathing circuit connections and the exhalation valve. At times this alarm can be caused by the patient breathing with the ventilator during inspiration which prevents the PIP from passing the minimum pressure.</p> <p>Mitigation/ Resolution: <i>Check Patient Connection, Check Circuit for Loose Hose/Tube, Check Exhalation Valve, Check Patient, Replace Circuit</i></p> <p>If Not Resolved: <i>**Manually Ventilate Patient**</i></p> |
| 2110 | Patient Detected | <p>An alarm triggers when you connect the patient to the ventilator while the Start Menu is active. To resolve the alarm, you must select a mode of ventilation and configure the device appropriately for the patient. In addition, you should perform the Operational Test procedure before reconnecting the patient to the device.</p> <p>Mitigation/ Resolution: <i>Backup Ventilation Started, Set Mode (AC, SIMV, CPAP, BL), Configure Other Settings</i></p> <p>If Not Resolved: <i>**Manually Ventilate Patient and Restart**</i></p> |
| 2170 | Spont. Breath PIP High | <p>Description: Alarm triggers when the airway pressure, PIP, exceeds the High PIP Limit Setting during 2 consecutive spontaneous breaths. The user should quickly check for kinked hoses/ tubes and check for airway obstruction. Suctioned the patient if necessary. The user should also check if the High PIP limit is set correctly or if the pressure support (PS) level is set too high.</p> <p>Mitigation/ Resolution: <i>Pressure Exceeds Limit Setting, Check Circuit for Kinked Hose/Tube, Check for Airway Obstruction, Suction Airway if Necessary, Check High Limit Setting</i></p> <p>If Not Resolved: <i>**Manually Ventilate Patient**</i></p> |
| 2171 | Spont. Breath PIP Low | <p>Description: Alarm triggers when the airway pressure, PIP, exceeds the Low PIP Limit Setting during 2 consecutive spontaneous breaths. The user should quickly check circuit for loose hoses/ tubes and also check the exhalation valve and the tube placement/ cuff. The user should also check if the Low PIP Limit is set correctly.</p> <p>Mitigation/ Resolution: <i>Check Patient Connection, Check Circuit for Loose Hose/Tube, Check Exhalation Valve, Check Tube Placement/ Cuff, Check Low Limit Setting</i></p> <p>If Not Resolved: <i>**Manually Ventilate Patient**</i></p> |
| 2172 | Spont. Breath Vt High | <p>Description: Alarm triggers when the high VT Limit is exceeded during 2 consecutive spontaneous breaths. The user should check: the patient connection, airway placement, breathing circuit for loose hoses/ tubes and also check the exhalation valve. The user should also check if the High VT Limit is set correctly.</p> <p>Mitigation/ Resolution: <i>Check Patient Connection, Check Circuit for Loose Hose/Tube, Check Exhalation Valve, Check Tube Placement/ Cuff, Check Limit Setting</i></p> <p>If Not Resolved: <i>**Monitor Patient**</i></p> |

| Service Code | Alarm Name | Mitigation/Resolution |
|--------------|------------------------------------|--|
| 2173 | Spont. Breath Vt Low | <p>Description: Alarm triggers when the Low VT Limit Setting is not achieved during 2 consecutive spontaneous breaths. When this occurs, the user should quickly check for kinked hoses/ tubes and check for airway obstruction. The patient should be suctioned if necessary. The user should also check if the Low VT limit is set correctly.</p> <p>Mitigation/ Resolution: <i>Check Circuit for Kinked Hose/Tube, Check for Airway Obstruction, Suction Airway if Necessary, Check Low Limit Setting</i></p> <p>If Not Resolved: <i>**Manually Ventilate Patient**</i></p> |
| 2300 | Self Check Fault | <p>Description: Alarm triggers when the pulse oximeter module fails while in use. The user cannot resolve this fault. When the alarm is active "-- --" displays in the HR and SpO₂ windows. Pressing the Mute/Cancel button silences the audible alarm for 30 seconds. To resolve the alarm, remove the probe from the device and put the pulse oximeter in standby "stby". Contact the service center for additional information.</p> <p>Mitigation/ Resolution: <i>Pulse Ox Module, Internal Failure, SpO₂/HR Not Available from Pulse Ox, Turn Off Pulse Ox, Remove SpO₂ Cable From Ventilator</i></p> <p>If Not Resolved: <i>**Contact Service Center**</i></p> |
| 2301 | Self Check Fault | <p>Description: Alarm triggers when the communication between the pulse oximeter module and device fails. When this occurs the user must turn off the pulse oximeter monitor to end the alarm condition through the SpO₂ Context menu while also removing the probe from the device. When this is done "stby" displays in the parameter windows for SpO₂ and HR as those parameters are no longer available. When appropriate the user should replace the ventilator and contact the service center for additional information.</p> <p>Mitigation/ Resolution: <i>Internal COMM: Pulse Ox Module, SpO₂/HR Not Available from Pulse Ox, Turn Off Pulse Ox, Remove SpO₂ Cable from Ventilator</i></p> <p>If Not Resolved: <i>**Contact Service Center**</i></p> |
| 2314 | Pulse Ox Sensor Off Patient | <p>Description: Alarm triggers when a pulse oximeter sensor loses the patient signal. The most common cause is when the sensor disconnects from the patient or is misaligned with the sensor site. This alarm can also be caused by poor perfusion at the sensor site which doesn't provide an adequate signal. In these cases try another site. Replace the sensor if another sensor is available. If the alarm condition cannot be resolved the user should remove the sensor from the patient and put the pulse oximetry monitor in standby "stby".</p> <p>Mitigation/ Resolution: <i>Check Pulse Ox Sensor Site, Check Patient for Peripheral Pulse, Change Placement, Check Sensor Operation, Replace Sensor,</i></p> <p>If Not Resolved: <i>**Turn Off Pulse Ox Monitoring**</i></p> |

| Service Code | Alarm Name | Mitigation/Resolution |
|--------------|----------------------|---|
| 2401 | SpO ₂ Low | <p>Description: Alarm triggers whenever the SpO₂ value drops below the Low SpO₂ Limit. The default value for the limit is 94%. Corrective actions are increasing oxygenation by increasing the FIO₂ or PEEP settings. PEEP should only be changed based on consultation with the attending physician. When using low flow O₂ the user should increase the flow of O₂ to the low flow O₂ reservoir.</p> <p>Mitigation/ Resolution: <i>SpO₂ Below Limit, Increase FIO₂, Check O₂ Supply, Increase PEEP Per Physician</i></p> <p>If Not Resolved: <i>**Consult Physician**</i></p> |
| 2410 | Heart Rate High | <p>Description: Alarm triggers when the heart rate is greater than the High Heart Rate Limit. The default value for the limit is 120 beats/minute. The user should consult with the attending physician on how best to reduce the heart rate to an acceptable level.</p> <p>Mitigation/ Resolution: <i>Heart Rate Above Limit, Check High Limit Setting</i></p> <p>If Not Resolved: <i>**Consult Physician**</i></p> |
| 2411 | Heart Rate Low | <p>Description: Alarm triggers when the heart rate is less than the Low Heart Rate Limit. The default value for the limit is 40 beats/minute. The user should consult with the attending physician on how best to increase the heart rate to an acceptable level.</p> <p>Mitigation/ Resolution: <i>Heart Rate Below Limit, Check Low Limit Setting</i></p> <p>If Not Resolved: <i>**Consult Physician**</i></p> |
| 2421 | Self Check Fault | <p>Description: Alarm triggers when there is a failure of the input protection circuit and the device is able to operate. The alarm will continue until the device is turned off. The user can mute the alarm for 30 seconds by pushing the Mute/Cancel button. The user should replace the ventilator and contact the service center for additional information.</p> <p>Mitigation/ Resolution: <i>Power System, Power System Needs Repair, Internal Battery Operation, Monitor Battery% Charge</i></p> <p>If Not Resolved: <i>**Contact Service Center**</i></p> |
| 2423 | Self Check Fault | <p>Description: Alarm triggers when the internal power circuit has failed and external power is connected but cannot be used. The fault cannot be repaired by the user. Pressing the Mute/Cancel button silences the audible alarm for 30 seconds. Replace the ventilator and contact the service center for additional information.</p> <p>Mitigation/ Resolution: <i>Power System, Power System Needs Repair, Internal Battery Operation, Monitor Battery% Charge</i></p> <p>If Not Resolved: <i>**Contact Service Center**</i></p> |

| Service Code | Alarm Name | Mitigation/Resolution |
|--------------|--------------------------------|---|
| 2430 | Nearly Drained Battery | <p>Description: Alarm triggers when the device detects that there is ≤ 5 minutes of battery operation remaining and external power is not connected. The user should immediately seek a source of external power and/or plan to provide manual ventilation. Attaching external power will immediately clear the alarm though a low priority alarm will remain until the internal battery has recharged so that the device can provide 30 minutes of operating time. This will take approximately 5 to 10 minutes. If recharging the battery does not resolve the issue, contact the service center for additional information.</p> <p>Mitigation/ Resolution: <i>≤ 5 Minutes Operation, Connect External Power, Ensure Ability to Manually Ventilate</i></p> <p>If Not Resolved: <i>**Contact Service Center**</i></p> |
| 2450 | Battery Discharge Fault | <p>Alarm triggers when the battery temperature reaches 70 °C (158 °F) which is 5 °C (41 °F) from its maximum operating temperature using the internal battery and external power is not connected. When the battery temperature reaches 75 °C (167 °F) the battery will shut down to prevent failure and the device will sound a high priority alarm and shutdown. If possible the user should provide a source of external power which will allow operation to continue at the current and higher temperatures. In addition, the device should be removed from the soft case which acts as insulation. Shading the patient and ventilator from direct sunlight may also help reduce the battery temperature.</p> <p>Mitigation/ Resolution: <i>Battery Within 5 °C of High Limit, Remove Padded Case, Ensure External Power Available, Ensure Ability to Manually Ventilate</i></p> <p>If Not Resolved: <i>**Move To Cooler Location**</i></p> |
| 2455 | Battery Fault | <p>Description: Alarm triggers when the device is not able to communicate with the internal battery. When this occurs the device does not know the current charge of the battery and operation could stop at any time. To continue operation and the user should connect external power and ensure the ability to manually ventilate the patient. When external power is connected the alarm priority decreases to Low Priority, replace the ventilator and contact the service center.</p> <p>Mitigation/ Resolution: <i>Battery Communication, Connect External Power, Ensure Ability to Manually Ventilate Patient</i></p> <p>If Not Resolved: <i>**Contact Service Center**</i></p> |

Low Priority Alarms

| Service Code | Alarm Name | Mitigation/Resolution Instructions |
|--------------|------------------|--|
| 3001 | Self Check Fault | <p>Description: Alarm triggers when the compressor fails to operate or fails to provide the flow required to deliver a breath within $\pm 10\%$ of the current settings, high pressure O₂ is available to provide ventilation and the user has set the FIO₂ to 100%. While operating in this state the user should ensure an adequate supply of O₂. Failure to maintain the O₂ supply will result in a high priority alarm. The user cannot repair the compressor, replace the ventilator and contact the service center for additional information.</p> <p>Mitigation/ Resolution: <i>Pneumatic System: Compressor, Ensure 55 psig/ 380 kPa O₂, O₂ Operation Only</i></p> <p>If Not Resolved: <i>**Contact Service Center**</i></p> |
| 3002 | Self Check Fault | <p>Description: Alarm triggers when communication between the compressor controller and SPM is lost, high pressure O₂ is available to provide ventilation and the user has set the FIO₂ to 100%. While operating in this state the user should ensure an adequate supply of O₂. Failure to maintain the O₂ supply will result in a high priority alarm and loss of ventilation. The user cannot repair the device, replace the ventilator and contact the service center for additional information.</p> <p>Mitigation/ Resolution: <i>Pneumatic System: Compressor, Ensure 55 psig/ 380 kPa O₂ Supply, O₂ Operation Only</i></p> <p>If Not Resolved: <i>**Contact Service Center**</i></p> |
| 3011 | Self Check Fault | <p>Description: Alarm triggers when the signal to the O₂ valve is outside of the calibration range for the required flow rate, the compressor is available to provide ventilation and the user has acknowledged that ventilation is being provided using the compressor by setting the FIO₂ to 21%. While operating in this state the user should monitor the SpO₂ to ensure that adequate oxygenation is maintained. If low flow O₂ is available it can be entrained through the Fresh Gas/ Emergency Air Inlet port using the optional O₂ reservoir. Maintain an acceptable SpO₂ by adjusting the O₂ supply up or down to increase or decrease the amount of O₂ delivered to the patient. The user cannot repair the O₂ valve, replace the ventilator and contact the service center for additional information.</p> <p>Mitigation/ Resolution: <i>Pneumatic System: O₂ Valve, Compressor Operation Only!, Keep FIO₂ at 21%, Connect Low Flow O₂, Monitor SpO₂</i></p> <p>If Not Resolved: <i>**Contact Service Center**</i></p> |

| Service Code | Alarm Name | Mitigation/Resolution Instructions |
|--------------|-------------------|--|
| 3012 | Self Check Fault | <p>Description: Alarm triggers when communication between the O₂ valve and SPM is lost, the compressor is available to provide ventilation and the user has set the FIO₂ to 21%. While operating in this state the user should monitor the SpO₂ to ensure that adequate oxygenation is maintained. If low flow O₂ is available it can be entrained through the Fresh Gas/Emergency Air Inlet port using the optional O₂ reservoir. Maintain an acceptable SpO₂ by adjusting the O₂ supply up or down to increase or decrease the amount of O₂ delivered to the patient. The user cannot repair the O₂ valve, replace the ventilator and contact the service center for additional information.</p> <p>Mitigation/ Resolution: <i>Pneumatic System: O2 Valve, Compressor Operation Only!, Keep FIO2 at 21%, Connect Low Flow O2, Monitor SpO2</i></p> <p>If Not Resolved: <i>**Contact Service Center**</i></p> |
| 3030 | Gas Intake Fault | <p>Description: Alarm triggers when the Fresh Gas/Emergency Air Inlet is blocked so that the compressor is not able to deliver breaths within $\pm 10\%$ of the current settings, high pressure O₂ is available to support ventilation and the user has set the FIO₂ to 100%. To clear the alarm, clear the blockage and set the FIO₂ back to the original value. If the blockage is cleared operation with the compressor will restart. If the blockage is not cleared, the alarm will resound, set the FIO₂ to 100%, continue ventilation and ensure an adequate supply of O₂. It is possible for this alarm to be a false alarm that is triggered in a very high vibration environment or if the device is not mounted correctly. If the alarm does not resolve contact the service center for additional information.</p> <p>Mitigation/ Resolution: <i>O2 Supply Operation, Clear Blocked Intake, Reset FIO2 to Previous, Monitor SpO2</i></p> <p>If Not Resolved: <i>**Contact Service Center**</i></p> |
| 3031 | Intake Restricted | <p>Description: Alarm triggers when the Fresh Gas/Emergency Air Inlet is blocked but is still capable of delivering breaths within $\pm 10\%$ of the current settings. This could be caused by an external blockage or a dirty/wet external or internal filter. If the blockage is cleared the alarm will automatically cancel. Refer to instructions for changing the internal filters. If the problem does not resolve contact the service center for additional information. On rare occasions, this alarm can be triggered by a patient with a very high inspiratory demand. In this case decrease the rise time or shorten the inspiratory time to increase the inspiratory flow rate.</p> <p>Mitigation/ Resolution: <i>Clear Fresh Gas Intake, Check Filter for Moisture or Dirt, OR, Manage Settings / Inspiratory Demand</i></p> <p>If Not Resolved: <i>**Manually Ventilate Patient**</i></p> |
| 3032 | Self Check Fault | <p>Description: Alarm triggers when communication between the Fresh Gas/Emergency Air Inlet pressure sensor is lost. Normal operation can continue but, if the condition is not cleared by powering off and restarting the device should be replaced when appropriate as. When used during this alarm condition the user should be sure to keep the Fresh Gas/Emergency Air Inlet clear and ensure that external filters are checked regularly.</p> <p>Mitigation/ Resolution: <i>Pneumatic Sensor, Ventilator Operating, Unable to Detect Inlet Obstruction</i></p> <p>If Not Resolved: <i>**Contact Service Center**</i></p> |

| Service Code | Alarm Name | Mitigation/Resolution Instructions |
|--------------|----------------------------------|--|
| 3041 | High O ₂ Supply Fault | <p>Description: Alarm triggers when the high pressure O₂ supply is ≥ 80 psig (552 kPa) and < 87 psig (600 kPa). The alarm automatically cancels when the supply pressure is < 80 psig (552 kPa). Pressure above 87 psig (600kPa) could result in a catastrophic failure, harm to the patient and/or damage to the device. The user should reduce the O₂ supply pressure, sometimes this requires replacing the regulator that is not functioning correctly. If the pressure cannot be reduced and a low flow device like a flow meter is available the user can provide supplemental O₂ via the optional low flow O₂ reservoir. If not, the user should monitor the O₂ supply pressure and ensure that the pressure does not rise further.</p> <p>Mitigation/ Resolution: <i>Decrease O2 Supply Pressure, Replace Regulator, Connect Low Flow O2, Monitor SpO2</i></p> <p>If Not Resolved: **Monitor O2 Supply Pressure**</p> |
| 3073 | Tubing Compliance Fault | <p>Description: Alarm is triggered when the tubing compliance correction shows that it is $>$ the set tidal volume indicating that the patient may not be receiving the appropriate tidal volume. In this case the user should assess the patient and settings. Consult the attending physician if there are questions about how to configure the ventilator correctly to support the patient.</p> <p>Mitigation/ Resolution: <i>Calculated Compliance Volume Larger than Delivered Volume, Check Tubing Compliance vs. Circuit</i></p> |
| 3091 | Auto-PEEP | <p>Description: Alarm triggers when the exhaled flow from the patient continues throughout the expiratory period causing the expiratory control valve to cycle throughout the period to maintain the baseline pressure. When this occurs the user should increase the expiratory period by decreasing the inspiratory time, decreasing the breathing rate or both. The physician should also be consulted as this alarm is an indication that AutoPEEP is occurring. Note: at startup, this alarm is off. The user can choose to activate the alarm if they believe the patient is at risk of AutoPEEP using the Alarm Configuration submenu that is access using the Menu.</p> <p>Mitigation/ Resolution: <i>Increase Expiratory Time, Decrease Inspiratory Time, Decrease Respiratory Rate, Disable Alarm,</i></p> <p>If Not Resolved: **Consult Physician**</p> |
| 3092 | Inspiratory Demand | <p>Description: Alarm triggers when the end-inspiratory pressure is < -1.0 cm H₂O (hPa) for 3 consecutive breaths. This can occur due to changes in the patient's status, where the patient attempts to inhale more gas than what is currently set. When this occurs, the user should note if the patient is breathing or fighting with the ventilator. The user should increase the flow rate (by decreasing the inspiratory time) and/or reduce the rise time. The physician should be consulted.</p> <p>Mitigation/ Resolution: <i>Patient May be Breathing with the Ventilator, Increase I Time and/or Decrease Rise Time, Check Patient and Circuit for Leaks, Disable Alarm</i></p> <p>If Not Resolved: **Consult Physician**</p> |

| Service Code | Alarm Name | Mitigation/Resolution Instructions |
|--------------|--------------------|--|
| 3110 | RTC Battery Low | <p>Description: Alarm triggers when the real-time clock (RTC) battery is < ~2.5 VDC. The alarm condition is checked at start up and if this alarm occurs the device is safe to operate but the user should replace the device when appropriate and consult the service center for additional information. The user cannot change the RTC battery. The RTC battery provides power for the clock that tracks the local time. It is replaced every 4 years during preventive maintenance.</p> <p>Mitigation/ Resolution: <i>Vent Fully Functional</i></p> <p>If Not Resolved: <i>**Contact Service Center**</i></p> |
| 3120 | PM Due | <p>Description: Alarm triggers at start up when the preselected number of days has elapsed since the last calibration. When appropriate the device should be replaced and sent for preventive maintenance. The low priority message serves as a reminder. Calibration is due every 365 days or 730 days for devices configured for stockpile use (check with your organization regarding the configuration of your device). Users should schedule the device for service as soon as possible. Users can suspend the yellow alarm notification for the current use by turning the alarm off using the Alarm Configuration submenu in the Menu.</p> <p>Mitigation/ Resolution: <i>Preventive Maintenance Due, Ventilator Functioning with No Faults</i></p> <p>If Not Resolved: <i>**When Appropriate, Contact Service Center**</i></p> |
| 3121 | Power Cycle Needed | <p>This alarm occurs when the device has been running continuously for 30 days. In order to check the flow pneumotach, which is done a startup, the user should manually ventilate the patient and cycle the power. Once this is done the user can select the Last Settings options from the Start Menu and continue operation if not faults are detected during the self check. If nonoperating alarms occur, contact the service center for additional information.</p> <p>Mitigation/ Resolution: <i>Power-on Self Checks are Due, When Appropriate, Power Off Then On, Verify Proper Settings</i></p> <p>If Not Resolved: <i>**Review Manual For Additional Information**</i></p> |
| 3130 | Self Check Fault | <p>Description: Alarm triggers when the ambient pressure transducer fails. When this occurs, the device is no longer able to automatically compensate for changes in altitude especially in situations where the ambient pressure could change rapidly as during transport by air. When this alarm is active during aeromedical transport the user should ventilate using pressure targeting if the ventilator cannot be replaced. Users should also monitor chest rise and breath sounds to ensure adequate ventilation.</p> <p>Mitigation/ Resolution: <i>Sensor: Barometer, Altitude Compensation Disabled, Maintain Airway Pressure, Check Patient Chest Rise, Avoid Use At Varying Altitude</i></p> <p>If Not Resolved: <i>**Contact Service Center**</i></p> |

| Service Code | Alarm Name | Mitigation/Resolution Instructions |
|--------------|---------------------------|---|
| 3131 | Excessive Altitude | <p>Description: Alarm triggers when the ambient pressure transducer detects an altitude > 25,000 ft (7620 m). Beyond this altitude compensation remains fixed at the 25,000 ft compensation level. The user should monitor the airway pressure and reduce the tidal volume as altitude increases though, there is very little change in performance over this altitude. Where possible cabin pressure should be maintained in the compensated range.</p> <p>Mitigation/ Resolution: <i>Beyond Altitude Compensation Limit, Maintain Airway Pressure, Check Patient Chest Rise, Monitor Ventilator/Patient</i></p> <p>If Not Resolved: <i>**Reduce Altitude/ Pressurize Cabin if Possible**</i></p> |
| 3132 | Low Altitude | <p>Description: Alarm triggers when the ambient pressure transducer detects an altitude of -2,000 ft below sea level. This can be caused by use in a subterranean rescue operation or mistaken use in a hyperbaric chamber.</p> <p>Note: The device is not intended for use in hyperbaric chambers or at hyperbaric pressures.</p> <p>Mitigation/ Resolution: <i>High Barometric Pressure Detected, Beyond Compensation Limit, Maintain Airway Pressure, Check Patient Chest Rise, Monitor Patient and Ventilator</i></p> <p>If Not Resolved: <i>**Reduce Ambient Pressure**</i></p> |
| 3140 | Ambient Temperature Fault | <p>Description: Alarm triggers when the ambient temperature exceeds the normal operating range, > 55 °C (131 °F) for the ventilator. The device allows operation at these temperatures but alerts the user to the condition. Operating above the specified range can affect the longevity of the internal battery and the duration of operating time. When operating at high temperatures the user should remove the padded case which insulates and increases the ventilator's internal temperature.</p> <p>Mitigation/ Resolution: <i>High Temperature Detected, Remove Padded Case</i></p> <p>If Not Resolved: <i>**Monitor Patient and Ventilator**</i></p> |
| 3141 | Ambient Temperature Fault | <p>Description: Alarm triggers when the ambient temperature falls below the normal operating range < -10 °C (14 °F) for the ventilator. The device allows operation at these temperatures but alerts the user to the condition. Operating below the specified range can affect the longevity of the internal battery and the duration of operating time. At extreme cold temperatures operating time can be significantly reduced. When operating at low temperatures always use the padded case which insulates and increases the ventilator's internal temperature.</p> <p>Mitigation/ Resolution: <i>Low Temperature Detected, Use Padded Case</i></p> <p>If Not Resolved: <i>**Monitor Patient and Ventilator**</i></p> |
| 3143 | Self Check Fault | <p>Description: Alarm triggers when there is failure of the internal temperature sensors. When this occurs the sensors are no longer able to detect when the device is operating outside of its specified temperature range, and the user should replace the ventilator and contact the service center for additional information.</p> <p>Mitigation/ Resolution: <i>Environmental Sensor: Temperature, Ventilator Operating, Service Required</i></p> <p>If Not Resolved: <i>**Contact Service Center**</i></p> |

| Service Code | Alarm Name | Mitigation/Resolution Instructions |
|--------------|-------------------------------|---|
| 3172 | Self Check Fault | <p>Description: Alarm triggers when the device is not able to zero the airway pressure transducer during the autocal cycle. When this occurs the device is still able to monitor the airway pressure safely. Large changes in temperature should be avoided which can affect the calibration of the transducer. This alarm can also be triggered when the device is exposed to excessive vibration and/or is mounted in a vehicle in a manner that increases its exposure to vibration. If the alarm continues, replace the ventilator and contact the service center for additional information.</p> <p>Mitigation/ Resolution: <i>Pneumatic Sensor: Autocal, Reduce Vibration if Possible, Avoid Temperature Changes, Autocal Suspended</i></p> <p>If Not Resolved: **Contact Service Center**</p> |
| 3300 | Self Check Fault | <p>Description: Alarm triggers when the pulse oximeter module fails and the user has turned off pulse oximeter monitoring acknowledging the condition. When this is done “stby” appears in the parameter windows for SpO₂ and HR as those parameters are no longer available. When appropriate the user should replace the ventilator and contact the service center for additional information.</p> <p>Mitigation/ Resolution: <i>Pulse Ox Module Not Available, SpO₂/HR Not Available</i></p> <p>If Not Resolved: **Contact Service Center**</p> |
| 3301 | Self Check Fault | <p>Description: Alarm triggers when the communication between the pulse oximeter module and device fails and the user has turned off pulse oximeter monitoring acknowledging the condition. When this is done “stby” appears in the parameter windows for SpO₂ and HR as those parameters are no longer available. When appropriate the user should replace the ventilator and contact the service center for additional information.</p> <p>Mitigation/ Resolution: <i>Internal COMM: Pulse Ox, Pulse Ox Module Failure, SpO₂/HR Not Available</i></p> <p>If Not Resolved: **Contact Service Center**</p> |
| 3310 | Pulse Ox Sensor Not Connected | <p>Description: Alarm triggers when the pulse oximeter detects that no SpO₂ sensor is connected after a period of successful operation. NOTE: During start up the device automatically detects if a sensor is connected. If it is, the device begins operation with the pulse oximeter active. If no sensor is detected the device turns off this function. If the sensor is properly connected this failure can also be the result of a broken or defective sensor. If the alarm condition cannot be resolved the user should remove the sensor and turn off pulse oximetry monitoring using the SpO₂ Context menu to put the monitor in standby. Contact the service center for additional information.</p> <p>Mitigation/ Resolution: <i>Check Pulse Ox Sensor, Check Sensor/Ventilator Connection, Reinsert Sensor, Replace Cable/Sensor, Replace Sensor</i></p> <p>If Not Resolved: **Contact Service Center**</p> |

| Service Code | Alarm Name | Mitigation/Resolution Instructions |
|--------------|-------------------------------------|--|
| 3311 | Defective Pulse Ox Sensor | <p>Description: Alarm triggers when the pulse oximeter cannot identify the connected sensor or the sensor has failed. Causes for this alarm include: broken sensor cable, inoperative sensor LEDs and/or faulty detector. If the alarm condition cannot be resolved the user should suspend pulse oximetry monitoring by placing it in standby "stby" using the SpO₂ Context menu.</p> <p>Mitigation/ Resolution: <i>Check Pulse Ox Sensor, Check Sensor/ Ventilator Connection, Reinsert Sensor, Cable/Sensor Damaged?, Replace Sensor</i></p> <p>If Not Resolved: <i>**Turn Off Pulse Ox Monitoring**</i></p> |
| 3312 | Pulse Search | <p>Description: Alarm triggers when the pulse oximeter is searching for a pulse signal. If a value is not displayed within 30 seconds disconnect and reconnect sensor and reapply to the patient. If pulse search continues, relocate it to a site that may have better perfusion. Replace the sensor if another sensor is available. If the alarm condition cannot be resolved the user should suspend pulse oximetry monitoring by placing it in standby "stby".</p> <p>Mitigation/ Resolution: <i>Please Wait Acquiring Signal, Check Sensor Placement, Change Placement of Probe, Minimize Patient Movement, Check Sensor Operation/Replace</i></p> <p>If Not Resolved: <i>**Turn Off Pulse Ox Monitoring**</i></p> |
| 3313 | Pulse Ox Signal Interference | <p>Description: Alarm triggers when an outside signal or energy source prevents accurate reading by the device. When this occurs the patient should be moved from the location or pulse oximeter turned off.</p> <p>Mitigation/ Resolution: <i>External Signal Interfering With Measurement, Remove Patient From Location</i></p> <p>If Not Resolved: <i>**Turn Off Pulse Ox Monitoring**</i></p> |
| 3315 | Ambient Light Fault | <p>Description: Alarm triggers when there is too much ambient light on the SpO₂ sensor or there is inadequate tissue covering the sensor detector. Most often this alarm condition can be resolved by shielding the sensor from ambient light.</p> <p>Mitigation/ Resolution: <i>Too Much Ambient Light, Shield Sensor From Light, Change Sensor Placement, Check Sensor Operation, Replace Sensor</i></p> <p>If Not Resolved: <i>**Turn Off Pulse Ox Monitoring**</i></p> |
| 3316 | Invalid Pulse Ox Sensor | <p>Description: Alarm triggers when the pulse oximeter does not recognize the connected sensor, i.e. a non-Masimo sensor. The alarm can also occur when there is a broken sensor cable, inoperative LEDs, a fault is detected and/or the sensor has failed. To resolve the alarm condition the sensor should be replaced. If the alarm condition cannot be resolved the user should turn off pulse oximetry monitoring by placing it in standby "stby".</p> <p>Mitigation/ Resolution: <i>Replace Sensor</i></p> <p>If Not Resolved: <i>**Turn Off Pulse Ox Monitoring**</i></p> |

| Service Code | Alarm Name | Mitigation/Resolution Instructions |
|--------------|--|--|
| 3317 | Low SpO₂ Perfusion | <p>Description: Alarm triggers whenever the amplitude of the arterial pulsation is weak. Low perfusion typically occurs in patients with poor circulation or when the sensor is applied to the same limb as the noninvasive blood pressure (NIBP) cuff. To resolve the alarm condition, move the sensor to a better perfused site or to another limb if the interference is from the NIBP cuff.</p> <p>Mitigation/ Resolution: <i>Pulse Signal Weak, Check Sensor Placement, Change Sensor Placement, Check Sensor Operation</i></p> <p>If Not Resolved: **Turn Off Pulse Ox Monitoring**</p> |
| 3318 | Low SpO₂ Perfusion | <p>Description: Alarm triggers when the pulse oximeter determines the quality of the input signal is low due to excessive motion or artifact. To resolve the alarm minimize patient movement and make sure the sensor is properly applied.</p> <p>Mitigation/ Resolution: <i>Signal Artifact, Minimize Patient Movement, Check Sensor Placement, Check Sensor Operation</i></p> <p>If Not Resolved: **Turn Off Pulse Ox Monitoring**</p> |
| 3421 | External Power Low / Disconnect | <p>Description: Alarm triggers when the external power (either AC or DC) drops below minimum level (~11 VDC as supplied by either the AC/DC Power Supply or a direct DC source) or power is intentionally disconnected. Since the device operates with either external power or using its internal battery this is a low priority alarm that clears when the user presses the Mute/Cancel button. Pressing the Mute/Cancel button is the user's acknowledgment that the device is operating on internal battery. If this alarm occurs and the user believes that the device is still connected to external power the user should investigate the external power source and contact the service center for additional information.</p> <p>Mitigation/ Resolution: <i>Internal Battery Operation, Check Power Connection/Supply, Monitor Battery Status</i></p> <p>If Not Resolved: **Contact Service Center**</p> |
| 3422 | Battery Fault | <p>Description: Alarm triggers when the internal battery has been removed or communication between the battery and CPU has failed. When external power is applied the device is capable of operation however, loss of external power will result in loss of ventilation and a high priority alarm. Operating in this state should only be done when no other alternatives are available.</p> <p>Mitigation/ Resolution: <i>Battery Power Not Available, DO NOT Remove External Power!, Maintain External Power</i></p> <p>If Not Resolved: **Contact Service Center**</p> |
| 3423 | Battery Charging Fault | <p>Description: Alarm triggers when the battery charging circuit fails. When this alarm is active, the battery cannot be charged. The device can only run with external power. If power is lost, ventilation will stop and a high priority alarm will trigger. Operating in this state should only be done when no other alternatives are available. Contact the service center for additional information.</p> <p>Mitigation/ Resolution: <i>Ventilator Operating, Power System Needs Repair, Battery Cannot Charge, Maintain External Power</i></p> <p>If Not Resolved: **Contact Service Center**</p> |

| Service Code | Alarm Name | Mitigation/Resolution Instructions |
|--------------|----------------------|---|
| 3430 | Low Battery | <p>Description: Alarm triggers when the device detects that there is < 30 minutes of battery operation remaining and no external power is connected. The user should seek a source of external power and/or plan to provide manual ventilation. Attaching external power will immediately clear the alarm however, SC: 3431 will occur in its place, see below.</p> <p>Mitigation/ Resolution: <i>< 30 Minutes Operation, Connect External Power, Ensure Ability to Manually Ventilate</i></p> <p>If Not Resolved: <i>**Contact Service Center**</i></p> |
| 3431 | Low Battery | <p>Description: Alarm triggers when external power is connected to a device that has an internal battery that has drained to a low battery status. The device is warning the user that in the event of an external power failure the device has < 30 minutes of backup. This alarm will resolve when the internal battery charge has > 30 minutes of operation. The user must maintain constant monitoring of the device and the patient during this period.</p> <p>Mitigation/ Resolution: <i>< 30 Minutes Operation, Operating With External Power, Continue Charging With External Power, Ensure Ability To Manually Ventilate</i></p> <p>If Not Resolved: <i>**Contact Service Center**</i></p> |
| 3441 | External Power Fault | <p>Description: Alarm triggers when the supplied DC power is > 33 VDC. When this occurs the device automatically switches to operation using the internal battery. If the supplied voltage drops to < 30 VDC the device automatically returns to operation using external power. If the external power source is known to be good then the AC/DC Power Supply may be faulty and need replacement. Contact the service center for additional information.</p> <p>Mitigation/ Resolution: <i>External Voltage Too High, Internal Battery Operation, Check/Replace Power Supply</i></p> <p>If Not Resolved: <i>**Remove DC Connection**</i></p> |
| 3442 | External Power Fault | <p>Description: Alarm triggers when the external power supply has insufficient current. When this occurs the device automatically switches to operation using the internal battery. If the external power source is known to be good then the AC/DC Power Supply may be faulty and need replacement. Contact the service center for additional information.</p> <p>Mitigation/ Resolution: <i>External Power Insufficient Current, Internal Battery Operation, Check/Replace Power Supply</i></p> <p>If Not Resolved: <i>**Remove DC Connection**</i></p> |
| 3444 | External Power Fault | <p>Description: Alarm triggers when the voltage polarity is reversed when the device is attached to an external DC source. When this occurs the device automatically switches to operation using the internal battery. This condition is most likely caused by a faulty DC source. The user should seek an alternate power source.</p> <p>Mitigation/ Resolution: <i>DC Voltage Reversed, Internal Battery Operation, Disconnect Power Source</i></p> <p>If Not Resolved: <i>**Replace Power Source**</i></p> |

| Service Code | Alarm Name | Mitigation/Resolution Instructions |
|--------------|--------------------------------|---|
| 3450 | Battery Discharge Fault | <p>Description: Alarm triggers when the battery temperature reaches 70 °C (158 °F) which is 5 °C (41 °F) from its maximum operating temperature and external power is connected. When the battery temperature reaches 75 °C (167 °F) the battery will shut down to prevent failure. When this occurs the device will continue operation using external power only. The device should be removed from the padded case which acts as insulation. Shading the patient and ventilator from direct sunlight may also help reduce the battery temperature.</p> <p>Mitigation/ Resolution: <i>Battery Within 5 °C of High Limit, Remove Padded Case, Continue External Power Operation, Shade Patient and Ventilator</i></p> <p>If Not Resolved: <i>**Move To Cooler Location**</i></p> |
| 3451 | Battery Discharge Fault | <p>Description: Alarm triggers when the battery temperature reaches ≥ 75 °C (167 °F) and external power is connected. Discharging the battery beyond this temperature could destroy the battery and damage the device. During the alarm condition the device will continue operation using external power. The device should be removed from the padded case which acts as insulation. Shading the patient and ventilator from direct sunlight may also help reduce the battery temperature.</p> <p>Mitigation/ Resolution: <i>Battery Too Hot to Discharge, Do NOT Remove External Power!, Remove Padded Case, Ensure Ability to Manually Ventilate Patient</i></p> <p>If Not Resolved: <i>**Move To Cooler Location**</i></p> |
| 3452 | Battery Charging Fault | <p>Description: Alarm triggers when the battery temperature is > 45 °C (122 °F). Charging the battery above this temperature could destroy the battery and damage the device. During the alarm condition the device continues to operate using external power and if external power is lost the device will operate using internal battery power. The device should be removed from the padded case which acts as insulation. Shading the patient and ventilator from direct sunlight may also help reduce the battery temperature.</p> <p>Mitigation/ Resolution: <i>High Battery Temperature, Battery Does Not Charge When It is Too Hot, Ensure External Power Available, Remove Padded Case, Shade Patient and Ventilator</i></p> <p>If Not Resolved: <i>**Move To Cooler Location**</i></p> |
| 3453 | Battery Charging Fault | <p>Description: Alarm triggers when the battery temperature is ≤ 0 °C (32 °F). Charging the battery below this temperature could destroy the battery and damage the device. During the alarm condition the device continues to operate using external power and if external power is lost the device will operate using internal battery power. The padded case should be used because it provides insulation.</p> <p>Mitigation/ Resolution: <i>Battery Too Cold To Charge, Ensure External Power Available, Use Padded Case</i></p> <p>If Not Resolved: <i>**Move to Warmer Location**</i></p> |

| Service Code | Alarm Name | Mitigation/Resolution Instructions |
|--------------|------------------|---|
| 3455 | Battery Fault | <p>Description: Alarm triggers when the device is not able to communicate with the internal battery and external power is connected. To continue operation, the device must remain connected external power. Use in this state should only be done if there are no other alternatives. Contact the service center for additional information.</p> <p>Mitigation/ Resolution: <i>Battery Communication, Do Not Remove External Power, Ensure Ability to Manually Ventilate Patient</i></p> <p>If Not Resolved: <i>**Contact Service Center**</i></p> |
| 3470 | Self Check Fault | <p>Description: Alarm triggers when the device is no longer able to communicate with the Power Interface Module (PIM). When this occurs the user should monitor operation continuously, replace the ventilator when possible and ensure the ability to manually ventilate the patient. Contact the service center for additional information.</p> <p>Mitigation/ Resolution: <i>Power System, Power Management Fault, Ensure the Ability to Manually Ventilate the Patient, Monitor Power Source</i></p> <p>If Not Resolved: <i>**Replace/Service Ventilator**</i></p> |
| 3480 | Self Check Fault | <p>Description: Alarm triggers when the device software detects that it has not been calibrated with the SPM that is inside the device. This fault occurs when the biomedical technician fails to recalibrate the device following an SPM change or service. When this occurs the device should be replaced when appropriate and sent to the service center.</p> <p>Mitigation/ Resolution: <i>Serial Number Mismatch, Hardware Compatibility Failure, Update Calibration Records</i></p> <p>If Not Resolved: <i>**Replace/Service Ventilator**</i></p> |

Chapter 6

Operating Environments

This chapter describes how to operate a ZOLL ventilator outside of a hospital environment. Topics include:

- When External Power is Unavailable
- Transport environments
- Harsh environments – prehospital and transport
- Hazardous environments – in the presence of chemical and/or biological toxins
- MRI environments – during MRI (magnetic resonance imaging) treatment

When External Power is Unavailable

Extending Battery Runtime

In environments where access to external power is not available, ZOLL testing demonstrates that operators can extend internal battery runtime up to 20% by adjusting screen brightness (See Chapter 4 for information on adjusting screen brightness). The table below lists ZOLL testing battery runtime results for a new, fully charged battery at various levels of screen brightness.

| Ventilator Screen Brightness Setting | Approximate Fully-Charged Battery Runtime* |
|---|--|
| 25 (Default) | 10 Hours |
| 16 | 11 hours |
| 8 | 12 hours |
| * Testing conducted with ventilator operating with default adult settings | |

Using an External Battery

Use the external battery cable provided with the ventilator to operate the device. The external battery icon will indicate when the power source is in use. The external battery does not charge the internal Li-ION battery and should be replaced with an external power source when available.

Using the Ventilator in Transport Environments

The ventilator is designed to be used in the field and transport environments including road ambulances, fixed wing and rotary wing transport vehicles.

Using the Ventilator in Harsh Environments

The ventilator is designed to operate in harsh prehospital environments and during air and ground transport. In order to safely manage the patient, you must understand the operating characteristics of the ventilator and diligently monitor the patient and device in these environments. The device continuously monitors environmental conditions (temperature and ambient pressure) and when it detects extreme environments, the device alerts you with a Low Priority alarm which defines the operating condition and prompts your actions. Low Priority alarms are advisory and you should remember that the device is operating as designed.

Airborne Particulates

Under normal operating conditions, the internal filtration system protects the gas flow path from particulates entrained through the Fresh Gas/Emergency Air Intake. However, when operating in areas where fine dust or dirt is airborne due to wind or vehicle movement, you should use a disposable bacterial/viral filter to preserve the internal filter. Using disposable filters prevents you from having to change the ventilator's internal filter and provides additional protection to the internal gas path component. Visually inspect the filter for dust/dirt build up for extended operation in harsh environments, you should change the filter as it becomes dirty.

The primary effect of entrained particles is on the operation of the flow pneumotach used to control the gas delivered to the patient. Dirt on the pneumotach screens affects the device's calibration. Cleaning the screens requires a biomedical technician to disassemble the device and ultrasonically clean the screens. Using a filter in dusty environments prevents having to remove the device from service for cleaning. In addition to using the filter, you can also keep the device in the soft case, which will protect the device case and the LCD from being scratched or damaged. It is also easier to clean the padded case following use in a dusty/dirty environment than the device.

Caution When the ventilator is deployed in dusty environments, but not in use, be sure to cover the Gas Output using the red cap, provided by ZOLL, that covered the Gas Output when the ventilator shipped.

Extreme Temperature Environments

The ventilator's recommended operating range is from 32 °F to 104 °F. However, the ventilator can operate over the extended range of -55 °F to 120 °F with limitations on battery use (charge and runtime), and can operate over the range of -15 to 131 °F during emergency situations.

For temperatures > 113 °F and < 32 °F the Li-ION batteries stop charging to prevent damage through excessive heat building. To ensure maximum operating time, the device automatically monitors the battery temperature and charges it whenever it is safe.

Operating at High Temperatures

When operating the ventilator at high temperatures, you may observe alarm conditions associated with Li-ION battery performance:

Note: If the device is stored ready for use at the temperature extremes, users should note the battery charging and discharging conditions identified below.

Charging — If operating using external power, the device may trigger an alarm when the battery reaches its high charge temperature limit of 113 °F. At this temperature Li-ION batteries stop charging to prevent damage through excessive heat building.

Compliance is a physical characteristic of the patient circuit that varies with temperature. The circuit becomes more compliant as the temperature rises. The ventilator allows you to increase the automatic compliance value when operating in hot environments via the main menu.

When operating at high temperatures, you should remove the device from its padded case, which allows the device to pass heat into the surrounding environment.

Operating at Low Temperatures

When operating the ventilator at low temperatures, you may observe alarm conditions associated with Li-ION battery performance:

Charging — If operating using external power, the device may issue an alarm when the battery reaches its low charge temperature limit of 32 °F.

Compliance is a physical characteristic of the patient circuit that varies with temperature. The circuit becomes less compliant as the temperature drops. The ventilator allows you to decrease the compliance value when operating in cold environments.

The O₂ Valve operating performance can be affected by extremely low temperatures.

Consequently, at low temperatures, you should monitor the patient to ensure that the patient is receiving adequate tidal volume and monitor the patient's SpO₂ readings.

At temperature ~ -14.8 °F you may have to run the device for a few minutes to exercise the O₂ Valve before attaching the ventilator to the patient.

When operating at low temperatures, you can improve performance by operating the device in the padded case, which insulates the device and allows it to retain heat generated by the compressor, circuit boards, and AC/DC Power Supply.

Altitude

ZOLL ventilators are designed to pneumatically operate from 110 to 37.6 kPa (-2,250 to 25,000 ft). An absolute barometric pressure sensor monitors ambient pressure and the device uses this information to continuously correct the output of the device to maintain the ventilation parameters. When the altitude is > 25,000 ft, the device activates a Low Priority alarm. When this occurs, you should monitor the peak inspiratory pressure (PIP) and adjust the tidal volume to maintain the PIP and monitor breath sounds and chest excursion to assure the device maintains adequate ventilation. The tidal volume increases as altitude increases, so you should look to prevent over-pressurization of the lung when the altitude increases beyond > 25,000 ft. If changes are made above > 25,000 ft, you should revert to the initial settings once operation resumes in the compensated range (the LED will turn from yellow to green).

Mains protection is ensured up to 16,400 ft (5,000 m) or cabins pressurized to at least 54kPa.

When defibrillation is needed above 10,000 ft (3,048 m), disconnect the SpO₂ sensor from the patient and proceed with defibrillation.

Warning! **The device is not intended for hyperbaric operation. Use in a hyperbaric chamber can result in harm to the patient and/or damage to the device.**

Rain and Snow

You should prevent exposing the device to rain or snow. Use the optional padded case provided with the ventilator to protect it from rain and snow. The device is capable of operating in these conditions if you keep the device in the padded case and use the rain flap that is provided with the padded case. Under these conditions battery operation is required, and the Pulse Oximeter patient cables are not connected to the device. The padded case and rain flap prevent rain and snow from puddling on any of the device's surfaces. In cases of driving rain, where water could possibly enter the device's compressor, you can use a bacterial/viral filter to protect the compressor inlet.

Using the Ventilator in Hazardous Environments

You can use the ventilator in environments where chemical and/or biological toxins are present. To do this safely, all gas delivered to the patient comes from either a pressurized medical-grade O₂ source and/or filtered ambient air entrained through the Fresh Gas/Emergency Air Intake. You can choose between a bacterial/viral filter and a C2A1 Chemical/Biological filter based on the direction of the Medical Control Officer. Hazardous environment filters are shown in Figure 6-1.

To prevent the patient from breathing contaminated ambient air in the event of a ventilator failure, the device contains an internal anti-asphyxia valve that allows the patient to inspire gas through the external filter. While this design assures that no contaminated gas reaches the patient, you must ensure that nothing blocks the input of the external filter.

Warning! **The Medical Control Officer and/or Incident Commander should determine which, if any, external filter is used based on the potential hazard.**

Warning! You must ensure that nothing blocks the inlet of the external filter; failure to do so could prevent the patient from breathing and cause a ventilator failure.

Bacterial/Viral Filter Use

You can use Bacterial/Viral (B/V) filters in environments where the patient is at risk from cross contamination of airborne pathogens. When used in accordance with the manufacturer's instructions, these filters can help prevent inhalation of infectious matter. In dusty environments, you can also use the B/V filters to prevent entrainment of particulate matter that could affect the ventilator's pneumatic components. To use a bacterial/viral filter, insert the filter's male 22 mm conical fitting into the Fresh Gas/Emergency Air Intake.

Warning! If filters have been exposed to biological matter, dispose of them following the Universal Precaution procedures for your facility.

Chemical/Biological Filter Use

ZOLL ventilators are designed to allow attachment of chemical/biological filter/canister (type C2A1¹) for use in contaminated environments. The Fresh Gas/Emergency Air Intake fitting allows for attachment of standard Rd 40 x 1/7 threads. A complete description of this standard can be found in BS EN 148-1:1999 Respiratory protective devices - Threads for face pieces.

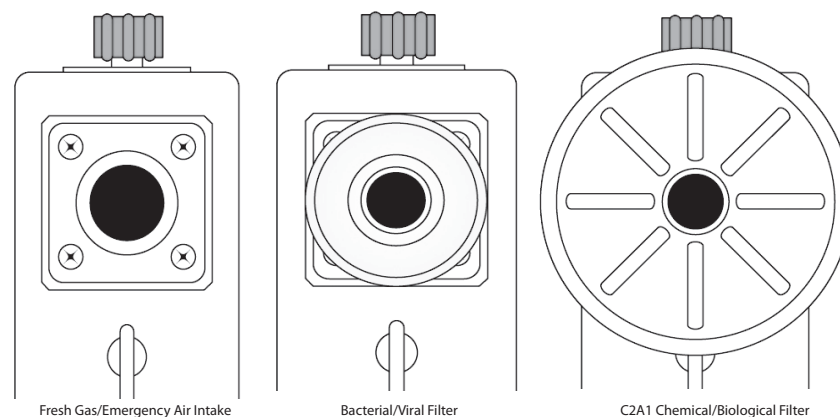

Figure 6-1 Hazardous Environment Filters

Note: ZOLL does not offer a C2A1 Chemical/Biological filter. This filter can be obtained from a Chemical/Biological filter supplier.

1. A 3M C2A1 canister (3M St. Paul, MN) was used in our validation testing to represent the class of filters generically known as C2A1 under the NSN number 4240-01-361-1319. These tests confirmed the performance of the ventilator when operating with these devices as a class. Use of the 3M canister does not constitute endorsement or recommendation of the 3M device. Use and selection of the appropriate filter should always be under the direction of the Incident Commander.

Check Valve on Patient Circuit when in Hazardous Environments

When operating in a hazardous situation where a chemical/biological filter is in use, you should use a check valve to prevent hazardous gas from entering the patient circuit. The exhalation valve on the patient circuit is not adequate to protect patients if they rapidly inhale/exhale as the valve may not fully close in time to prevent hazardous gas entrainment.

Also, if the PEEP is set low, patients may inhale faster than the flow is delivered which could cause hazardous gas entrainment. Consequently, a Check Valve is required to protect patients.

Warning! The device is shipped with both the pediatric/adult and infant/pediatric single limb circuits. A check valve is required with these patient circuits when operating in chemical/biological environments. The correct mating of the check valve with the patient circuit is shown in Figure 6-2. Users who anticipate use in these environments should also stock the check valve.

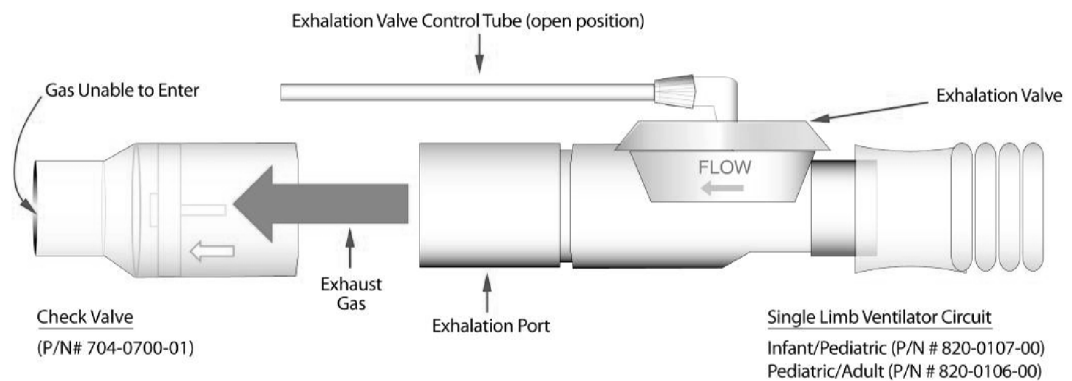

Figure 6-2 Check Valve Connection To Patient Circuit

Using the Ventilator in an MRI Environment

You can use ventilator in an MRI environment using a ZOLL MRI Roll Stand with an Aluminum IV Support Arm. To securely mount the ventilator, tighten the knob on the back plate of the roll stand to hold the ventilator in position, then lock the roll stand wheels (we also recommend that you tether the rolling stand in place). See Figure 6-3.

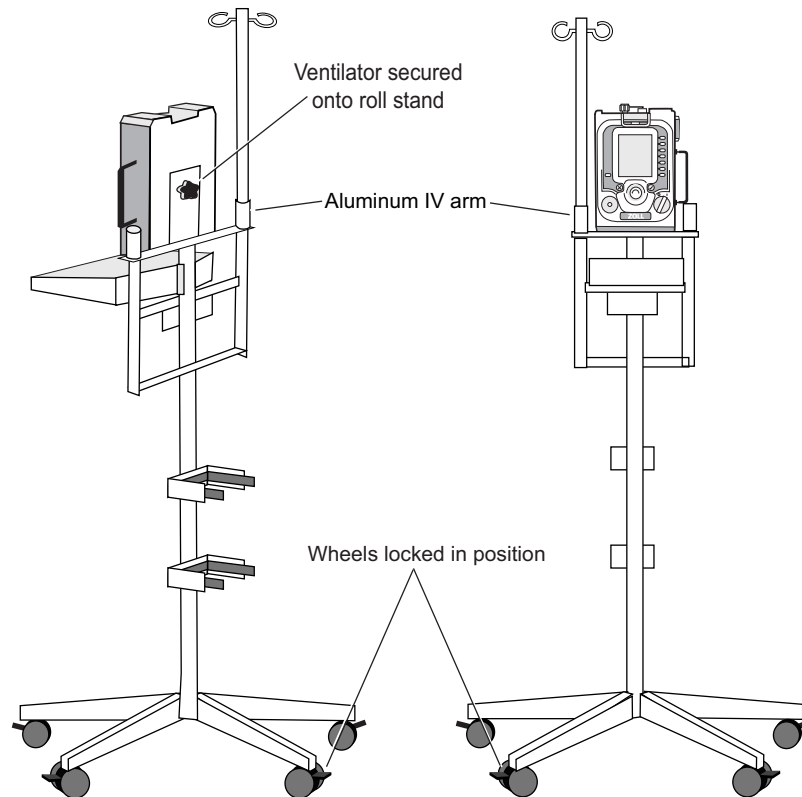

Figure 6-3 Ventilator Mounted on MRI Rolling Stand With IV Support Arm

Warning!



Use only ZOLL ventilators marked with the MR Conditional symbol in an MRI environment. Figure 6-4 shows the MR Conditional label and describes the location of it on ventilator models supporting MRI environments. Figure 6-5 shows an example of MR Conditional label placement on the Z Vent ventilator model.

Before using the ventilator in an MRI environment, it is important that you read and understand all warnings in the “MR Conditional Equipment” section of Chapter 1.

Warning!

The ventilator must be placed behind the 130 Gauss line.

ZOLL offers 12 ft (3.7 m) patient circuits to accommodate the length required to place the ventilator behind the 130 Gauss line.

Warning!

The use of longer breathing circuits may increase the risk of self-triggering ventilator breaths. Reducing the pressure trigger sensitivity may solve this problem.



| Ventilator Model | Location of MR (MRI) Label |
|------------------|---|
| Z Vent MR | Right side of front panel at bottom |
| EMV+ MR | Center of front panel at bottom |
| Eagle II MR | Center of front panel at bottom and center of side panels at the bottom |

Figure 6-4 Conditional MR Label and Location on Ventilator Models Supporting MRI Environments

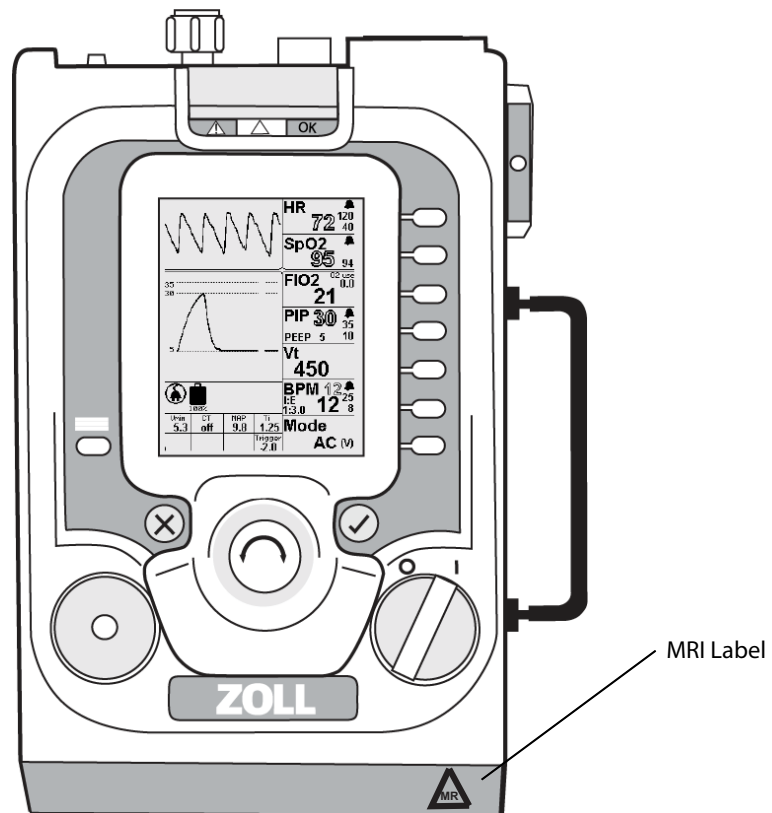

Figure 6-5 Example: Conditional MR Label Placement on Z Vent Ventilator

Chapter 7

Maintenance

This chapter describes how to maintain a ventilator to ensure its optimum working condition and readiness for immediate use. Specifically, this chapter describes how to:

- Inspect the device
- Clean the device
- Replace intake filter, as necessary
- Store the device
- Troubleshoot operational problems

In addition to the activities that we describe in this chapter, it is also important to perform preventative maintenance, replacing worn or defective components, as necessary. Only ZOLL-trained and certified personnel should perform preventative maintenance using ZOLL's Remote Calibration System (RCS) system.

Inspecting the Ventilator

You should perform the following physical inspections of the ventilator on a regular basis:

- Ensure that the ventilator is clean and free of visible damage.
- Inspect all accessories and connectors for signs of damage or excessive wear. Replace worn or defective items.
- Examine high pressure hoses for cracking, discoloration, or disfigurement. Examine end connection fittings for damaged threads and sharp edges. Replace worn or defective hoses – **Do Not** attempt to repair hoses.
- Examine the ventilator circuits for damage or wear including cracking or discoloration. If there are signs of physical degradation or the ventilator trigger circuit related alarms, replace the patient circuit.
- Examine the Fresh Gas/Emergency Air Intake filter and replace it if dirty, damaged, or clogged.
- Inspect the external AC/DC adapter, line cords, and DC power cables for wear or damage. Replace if worn or damaged.

Configuration and firmware information appears on the display screen after powering on the device. Additional device information is available through the Menu (select **Unit Info**), including the device's calibration date. For most customers, the ventilator operates on an annual preventative maintenance cycle, and the device issues a low priority alarm to remind you when calibration is due.

Note: The alarm is based on a countdown timer. It does not indicate an issue with the ventilator, only that 365 days have passed and you should schedule preventative maintenance.

Cleaning

Keep the ventilator and its accessories clean at all times. **Never** allow grease or oil to enter the system or coat its components.

Clean the device at regular intervals and maintain up-to-date records of inspections, cleaning, and maintenance.

Take care to prevent liquids from entering the ventilator. **Never** submerge the ventilator and avoid using excessive amounts of water that might enter the device. Dry all exposed parts following use in wet environments.

Clean the device's housing and hose connections with a damp, soapy cloth.

For general decontamination and cleaning, apply a 10% bleach solution with a damp cloth.

Do not clean the device with abrasives or chlorinated hydrocarbon cleansers, which damage the housing and interface lens.

After cleaning, thoroughly dry the device with a lint-free cloth. Make sure that all exposed surfaces are cleaned and dried.

Warning! **Never use oil or grease of any kind with oxygen or compressed gas equipment.**

Post-Contaminated Environment Cleaning

If you have used the ventilator in an environment where it may have been exposed to contamination from a hazardous materials accident, mass epidemic, or weapon of mass destruction, we recommend that you follow these guidelines:

1. Always follow the decontamination procedures specified by the local Incident Command Safety Officer.
2. You should clean and decontaminate the equipment as soon as possible after use. Personnel should always wear the appropriate Personal Protective Equipment while decontaminating equipment.
3. *Review the cleaning instructions that we provide in the previous section.*
4. Since the potential list of contaminants that the ventilator might be exposed to is so large, it is difficult to provide an appropriate cleaning method for each type of exposure. An effective cleaning agent for one type of exposure may not be effective with another. Cleaning and sterilizing practices may vary between institutions. We suggest that each facility have in place a procedure for the cleaning and disinfection of its medical equipment and that these procedures be consulted for further guidance.

Fresh Gas/Emergency Air Intake Filter

The Fresh Gas/Emergency Air Intake (located on the right side of the ventilator) has a disk filter. As we describe in Chapter 6, “Operating Environments,” additional filter protection may be necessary when operating the device in extreme environments. These filters are replaced every year during the preventative maintenance performed by a ZOLL authorized service center.

Caution Do not operate the compressor without a disk filter in place.

Inspecting and Replacing the Disk Filter

The Fresh Gas/Emergency Air Intake Disk Filter provides filtration to the ambient air that is delivered to the patient. You must check this filter periodically and replace it if necessary. The ventilator triggers an alarm when the disk filter becomes dirty. This alarm indicates that the device is still able to deliver the correct tidal volume but the filter needs replacement. You can visually inspect the Fresh Gas/Emergency Air Intake Disk Filter. If the filter appears discolored, replace it.

Warning! If a filter is exposed to biological matter, dispose of it following Universal Precaution procedures for your facility.

Caution There are no user serviceable parts except the filter component above. Opening the case can damage the ventilator.

Caution When used in dusty/dirty environments, you should check the disk filter and replace it as needed. This prevents particle build up on the transducer screen and the need to take the device out of service for maintenance by a service technician.

Note: Do not attempt to clean this filter and do not operate the internal compressor without a filter in place.

Replacing Ventilator Filter

Tools needed:

- Hemostat or tweezers
- Torque Driver (with #2 Phillips Bit)

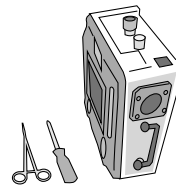

Warning! Before attempting to replace filter, make sure that external power is disconnected and that the ventilator’s power switch is set to “OFF”.

Replacing the Disk Filter

1. Remove the four (4) 8-32 x 3 Phillips Flat Head screws that secure the Fresh Gas/ Emergency Air Intake assembly to the cover.

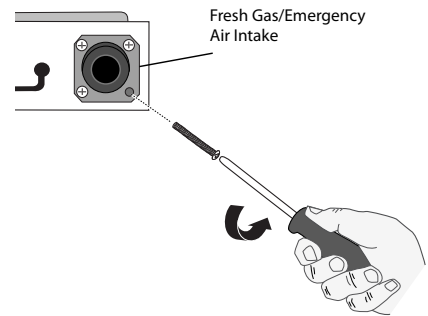

2. **Lift the two (2) segments of the Compressor Inlet Fitting Assembly away from the device.** If the two segments come apart, *do not* lose the gasket that seats between the parts.

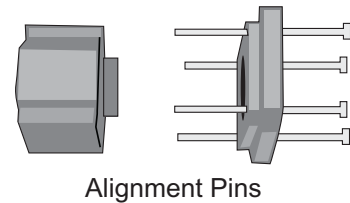

The Disk Filter is now exposed. *Do not* remove the filter at this time.

3. **Examine the surface of the Disk Filter.** *Do not* replace the Disk Filter if it isn't discolored. If the Disk Filter is discolored, replace the filter.

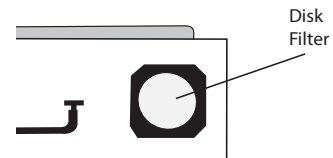

4. Remove the Disk Filter using the hemostat or tweezers and replace it with a new, clean filter. Make sure that the filter sits flat on the shoulder in its recessed area.



5. **Insert the lower segment of the Compressor Inlet Fitting Assembly into the device, making sure that its alignment pin mates.**

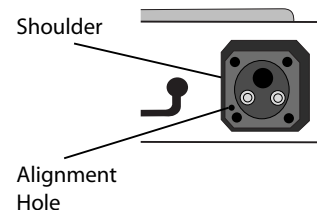

6. **Set the upper segment of the Compressor Inlet Fitting Assembly into the lower segment, making sure that its alignment pin mates.**
7. **Secure the Compressor Inlet Fitting Assembly to the device by equally tightening each of the four (4) 8-32 x 3 Phillips Flat Head screws. Tighten screws to 1.6 Nm.**

Momentarily turn the device's Power switch to its on position "I" to confirm operating power, then turn the device's Power switch to its off position "O".

8. Test the operation of the ventilator using a patient circuit and test lung

Battery Maintenance

The ventilator uses a rechargeable Li-ION battery, which offers a wide operating temperature range, and long operating time. Avoid exposing the battery to direct sunlight or heat sources.

Following the guidelines that we describe in this chapter prevents premature charge depletion and reduction of the battery's life.

Observe the warnings and cautions and that follow for safe use of the battery:

Warning! If you witness a battery or the battery compartment starting to balloon, swell up, smoke, or feel excessively hot, manually ventilate the patient, turn off the device, disconnect external power, and observe it in a safe place for approximately 15 minutes and send the device for service. Never puncture or disassemble the battery packs or cells.

Caution Only use the power supply provided with the device. Use of any other power supply could cause damage or create a fire and/or destroy the battery and ventilator.

Caution Never attempt to completely discharge the battery by shorting it or some other method and never ship the battery in a completely discharged state.

Caution During continuous, uninterrupted use (> 100 hours), you should disconnect the ventilator from AC power for 30 seconds to allow the battery to run diagnostics while the battery is discharging.

Note: The ventilator continuously monitors the available power sources; occasionally a false Low Priority power alarm can be triggered for approximately 1 second. These false alarms immediately clear themselves.

When operating from battery always monitor the battery charge state via the battery icon that provides both a graphical and numeric indication of the remaining battery power. The ventilator monitors temperature and controls the charging and discharging of the battery under the following conditions:

- Best operating conditions are 15 to 40 °C (59 to 104 °F)
- - 20 to 60 °C (- 4 to 140 °F) for for discharging
- 0 to 45 °C (32 to 113 °F) for charging

The battery rapidly recharges to 90% of its runtime in approximately 2 hours. It takes approximately another 2 hours of trickle-charging to top off the battery to 100% of its runtime.

While in use, continuous connection to external power operates the ventilator and ensures a fully charged battery. While off continuous connection to external power fully charges the battery.

Note: When connected to power for an extended period of time (> 30 days), the device indication may drop below 100% stored charge which allows the battery to perform diagnostics. To reset, power cycle by removing and reconnecting the connection to external power. Once this is done, the battery will recharge back to 100% in a few minutes.

Note: If when operating on battery power the device shuts down due to loss of power, connect external power and power cycle the device to restore function.

Battery Storage

Li-ion batteries discharge during storage. Higher temperatures (above 20 °C (68 °F)) reduce the battery storage life.

Follow these rules to ensure the best storage life of the ventilator's batteries:

- Always store the ventilator with the battery fully charged. DO NOT store the ventilator with the batteries discharged.
- For long-term storage, the optimum storage temperature range is -15 to 21 °C (5 to 71 °F). Avoid exposing the battery to direct sunlight or heat sources. It is not recommended to store batteries at high temperatures (above 40 °C (113 °F)).
- If long-term storage/non-use is common, recharge the device every six months; this ensures that the battery charge is maintained at 80% capacity or better.
- When batteries are in extended storage, you should charge them at recommended intervals. There is no need to store the device continuously connect to power. This can shorten the useful life of the battery.

| Ambient Storage Temperature | Recharge Interval |
|-------------------------------|-------------------|
| 20 °C (Below (68 °F)) | 12 months |
| 20 to 30 °C (68 °F to 86 °F) | 6 months |
| 30 to 40 °C (86 °F to 104 °F) | 3 months |

Note: When charging in the storage case, be advised that the battery may stop charging if ambient temperature is above 40 °C (104 °F), even though the device is still connected to external power. Under these conditions, battery temperature can get considerably hotter than the ambient temperature. Charging automatically starts when the battery temperature drops below 45 °C (113 °F).

Caution DO NOT store the ventilator with batteries in a discharged condition.

Battery Replacement and Shipping Regulations

Only trained technicians at an authorized ZOLL Service Center can replace the ventilator's battery. Contact your local service center for return instructions and please note the following:

- Shipping of the ventilator's battery should always use proper State of Charge (SOC), which must never exceed 30%. The ventilator's Rechargeable Li-Ion battery follows these and other important regulations, which IATA/DOT UN 38.3 mandates.
- The ventilator's battery is less than 100 Wh, and thus is Classified as Class 9 Exempt and does not require Class 9 labeling or marking.
- Always check all applicable local, national, and international regulations before transporting a Lithium-Ion battery.
- Transporting an end-of-life, damaged, or recalled battery may, in certain cases, be specifically limited or prohibited.

Ventilator Storage

For optimal prolonged storage, you should store the ventilator indoors and follow the battery storage recommendations described in this chapter.

The environment should be clean and out of direct sunlight. For storage in uncontrolled environments, remove batteries from ventilator if temperatures might exceed the battery storage temperature limits described in the section above.

The Gas Output port should be covered using the red Gas Output cap provided with the ventilator at shipment.

Following 6 months (or longer) of continuous storage or non-use, inspect the device, perform an Operational Test, and recharge the device's batteries before attempting to use it with a patient.

If the device has been stored in non-controlled environments (such as a vehicle), allow the device sufficient time (three hours) to stabilize to a temperature within its specified operating range. The ventilator is available with transit and carry case options. Follow the instructions that we provide with the transit or carry case.

Calibration Checks

The ventilator continuously performs a self check to monitor the pneumatic system.

The ventilator's calibration is checked as part of the annual service procedure. You should send the ventilator for preventative maintenance:

- Every 12 months.
- Whenever significant usage or rough handling warrants a shorter period between preventative maintenance inspections.
- Whenever you suspect the device is not functioning properly.
- Following mass deployment before the device is returned to storage.

If the ventilator fails the self-check, restart the device, if it fails again, it should be returned to ZOLL or an authorized Service Center for calibration.

Pulse Oximeter Check

A Masimo pulse oximeter tester is available to confirm operation of the HR and SpO₂ functions. The recommended tester is directly available from Masimo (PN 1593).

Note: A functional tester cannot be used to assess the accuracy of a pulse oximeter probe or a pulse oximeter monitor.

Electrical Safety Check

The ventilator's power system has an internal protection system that monitors the device at start up and continuously during operation. In event of a fault or failure condition the device triggers an alarm.

Electrical Safety Test conducted during service in accordance to IEC 60601-1 is addressed in the Service Manual.

Troubleshooting

You can quickly address common problems by following the Smart Help instructions. Should the device fail to operate properly, verify the integrity of all accessories, ventilator circuits, and fitting connections. Check all control panel settings and follow the alarm mitigation instructions provided in the Smart Help message(s).

Verify that the Fresh Gas/Emergency Air Intake disk filter is not clogged or dirty. Check for operating power from the internal battery and external power sources.

If the actions above do not resolve an operating problem, service is required. Note the service code number(s) and contact the closest authorized ZOLL Service Center or the ZOLL Customer Service Department (techsupport@zoll.com).

Appendix A

Specifications

General

| Parameter | Operating Range |
|---------------------------------|--|
| Operating Modes* | AC, SIMV, CPAP with and without Pressure Support, BL Mode, and Leak Compensation for Invasive and Noninvasive ventilation |
| Breath Target | Volume or Pressure |
| Flow Rate | 0 to 100 LPM at 40 cm H ₂ O (40 hPa) |
| Breath Rate | 1 to 80 BPM ± 1 BPM over the interval Setting Resolution: 1 BPM Reading: 1 to 90 BPM ± 1 BPM over the interval |
| Inspiratory Time* (Ti) | Setting: 0.1 to 3 ± 0.1 sec for I:E from 1:1 to 1:99 0.1 to 5 ± 0.1 sec for I:E from 4.0:1 to 1:99 (Inverse I:E) Setting resolution: 0.05 s |
| Tidal Volume | Setting: 50 to 2000 ml Resolution: 10 ml (above 100 ml), 5 ml (below 100 ml) Measurement: 50 ml to 3000 ml ± (5 ml + 10%) ATPD |
| FIO ₂ | 21 to 100% ± (3% of full scale ± 10% of setting) |
| PEEP | Setting: 0 to 30 cm H ₂ O (30 hPa) Setting Resolution: 1 cm H ₂ O (hPa) Reading: 0 to 30 cm H ₂ O ± (2 cm H ₂ O + 8% of reading) or, 0 to 30 hPa ± (2 hPa + 8% of reading) |
| Peak Inspiratory Pressure (PIP) | Setting: 10 to 80 cm H ₂ O (0 to 80 hPa) Setting Resolution: 1 cm H ₂ O (hPa) Reading: 0 to 99 cm H ₂ O ± (2 cm H ₂ O + 8% of reading) or 0 to 99 hPa ± (2 hPa + 8% of reading) |
| Pressure Support (PS) | Setting: 0 to 60 cm H ₂ O (kPa) Setting Resolution: 1 cm H ₂ O (kPa) Reading: 0 to 60 cm H ₂ O ± (2 cm H ₂ O + 8% of reading) or, 0 to 60 kPa ± (2 kPa + 8% of reading) |

Specifications

| Parameter | Operating Range |
|------------------------------------|---|
| EPAP | Setting: 3 to 30 cm H ₂ O (30 hPa) Setting Resolution: 1 cm H ₂ O (hPa) Reading: 3 to 30 cm H ₂ O ± (2 cm H ₂ O + 8% of reading) or, 3 to 30 hPa ± (2 hPa + 8% of reading) |
| IPAP | Setting: 6 to 60 cm H ₂ O (kPa) Setting Resolution: 1 cm H ₂ O (kPa) Reading: 0 to 60 cm H ₂ O ± (2 cm H ₂ O + 8% of reading) or, 0 to 60 kPa ± (2 kPa + 8% of reading) |
| Mean Airway Pressure (MAP) | (0 to 40 cm H ₂ O ± (2 cm H ₂ O + 8% of reading) or, (0 to 40 hPa ± (2 hPa + 8% of reading) |
| Airway Pressure High Limit | Setting: 20 to 100 cm H ₂ O (20 to 100 hPa) Setting Resolution: 1 cm H ₂ O (hPa) |
| Airway Pressure Low Limit | Setting: Off, 3 to 35 cm H ₂ O (3 to 35 hPa) Setting Resolution: 1 cm H ₂ O (hPa) |
| Breath Trigger | Setting: -6.0 to -0.5 cm H ₂ O (-6.0 to -0.5 hPa) Setting Resolution: .5 cm H ₂ O (5 hPa) |
| Airway Pressure Waveform | 0 to 99 cm H ₂ O ± (2 cm H ₂ O + 8% of reading) or, 0 to 99 hPa ± (2 hPa + 8% of reading) |
| Minute Volume | 0 to 70 liters per minute (trend) |
| Oxygen Input Pressure | Nominal: 55 psig (380 kPa) Extreme Range: 40 to 87 psig (280 to 600 kPa)** |
| LED Status/Alarm Indicator | Red, Yellow, and Green |
| Alarm Volume | 80 dBA @ 1 meter |
| Noise Level | ~60 dBA when measured at 1 meter (operating at default settings using the compressor only) |
| Operating Voltages | AC Supply: 100 to 240 VAC (50/60 and 400 Hz) -- use only the AC/DC power supply that ZOLL provides with the ventilator. DC Supply: Nominal 12.5 to 30.3 VDC (accepts DC voltages between 11.8 to 30.3 VDC). |
| Operating Time Internal Battery | 10 hours at default settings** |
| Ventilator Temperature Ranges | Standard Operating Temperature: -10 °C to 40 °C Extended Operating Temperature: -13 °C to 49 °C ** Extreme Operating Temperature: -26 °C to 55 °C ** |
| Battery Temperature Ranges | Battery Charge: 0 °C to 45 °C Battery Discharge: -20 °C to 60 °C |
| Size | 8.0" Wide x 12.5" High x 4.5" Deep (20.3 cm Wide x 31.8 cm High x 11.4 cm Deep) |
| Weight | ~9.7 lbs (4.4 kg) |
| Battery Weight | Nominal Weight: 1.4 lbs (643 g) |
| Warranty | Limited, 1 year |
| Altitude | Standard Altitude: 110 to 70 kPa (-2,250 ft to 10000 ft) Extended Altitude: 70 to 57.2 kPa (10000 ft to 15000 ft) Extreme Altitude: 57.2 to 37.6 kPa (15000 ft to 25,000 ft) |
| Altitude with respect to Isolation | Defibrillation Proof Protection: Up to 70 kPa (10,000 ft) Mains Protection: Up to 54 kPa (16,000 ft) |
| Extreme Operational Humidity | 15% to 95% non-condensing |

| Parameter | Operating Range |
|--|---|
| Transport and Storage | Temperature: -40 °C to 70 °C Humidity: 15 to 95 % RH (non-condensing) |
| Vibration | IEC 60068-2-6, IEC 60068-2-64 |
| Shock | IEC 60068-2-27 |
| Bump | IEC 60068-2-29 |
| Shock/Vibration (Military) | MIL-STD-810G, Method 514.6, Procedure I: Jet Aircraft, Fixed Wing, and Rotary Wing |
| Road Ambulance EN 1789 | EN 1789:2007+A2:2014 Medical vehicles and their equipment. Road ambulances. (Sections applicable to medical device) |
| Commercial Aircraft RTCA/DO-160G | Environmental Conditions and Test Procedures for Airborne Equipment Vibration (Section 8): Fixed wing Category S and Helicopter Category U2, Zones 1&2 EMC (Section 21): Category M, Conducted and Radiated emissions. Applicable only to Class I supply with C6 receptacle. |
| * Not all features available on all models. See Chapter 4 for feature availability. ** No degradation of performance due to extended or extreme temperature environments. See Chapter 6 for battery alarm indications and limitations. | |

Pulse Oximeter

| Parameter | Specification |
|---------------------------|--|
| Range | Saturation (% SpO ₂): 1% to 100% Pulse Rate (bpm): 25 to 240 Perfusion: 0.02% to 20% |
| Accuracy | Saturation (% SpO ₂) - During No Motion Conditions: Adults, Pediatrics: 70%-100% ± 2 digits, 0%-69% unspecified Neonates: 70%-100% ± 3 digits, 0%-69% unspecified Saturation (% SpO ₂) - During Motion Conditions Adults, Pediatrics: 70%-100% ± 3 digits, 0%-69% unspecified Neonates: 70%-100% ± 3 digits, 0%-69% unspecified |
| Pulse Rate (bpm) | Pulse Rate (bpm) - During No Motion Conditions: Adults, Pediatric, Neonates: 5 to 240 ± 3 digits Pulse Rate (bpm) - During Motion Conditions Adults, Pediatric, Neonates: 5 to 240 ± 5 digits |
| Resolution | Saturation (% SpO ₂): 1%, Pulse Rate (bpm): 1 |
| Low Perfusion Performance | >0.02% Pulse Amplitude Saturation (% SpO ₂) ± 2 digits and % Transmission >5% Pulse Rate ± 3 digits |
| Interfering Substances | Carboxyhemoglobin may erroneously increase readings. The level of increase is approximately equal to the amount of carboxyhemoglobin present. Dyes, or any substance containing dyes, that change usual arterial pigmentation may cause erroneous readings. |

Device Classification

The following table describes the ventilator's device classification:

| Category | Classification |
|--|--|
| Type of Protection against Electric Shock IEC 60601-1 | The power supply contains the system's safety barrier. See Chapter 2 for the ZOLL part number specification. <ul style="list-style-type: none"> When a three-prong style termination supply is selected the device complies with Class I specifications. When a two-prong style termination supply is selected the device complies with Class II specifications. |
| Degree of Protection against Electric Shock Applied Parts | The ventilator circuit is Type BF applied part. The pulse oximeter is Type BF Defibrillation Proof Applied Part. Defibrillation Proof up to 70 kPa (10,000 ft). |
| Degree of Protection against Harmful Ingress of Water | IP54: Dust protected and splash-proof equipment rating, include: <ul style="list-style-type: none"> Padded case (recommended) Bacterial/viral filter to protect the compressor |
| Method of Sterilization or Disinfection | O ₂ Supply hoses and connections should be wiped with a damp, soapy cloth and thoroughly dried with a lint-free cloth. The device's housing should also be cleaned as necessary with a damp, soapy cloth and thoroughly dried with a lint-free cloth. Do not clean with abrasives or chlorinated hydrocarbon cleansers. Disposable ventilator circuits are only for single use. Follow all IFU instructions. Reusable circuits must be sterilized according to product labeling included with the accessory. |
| Degree of Safety of Application in the presence of a Flammable Anesthetic Mixture with Air or with Oxygen or Nitrous Oxide | Equipment <i>not</i> suitable for use in presence of Flammable Anesthetic Mixture of Air or with Oxygen or Nitrous Oxide |
| Mode of Operation | Continuous Operation |

Emissions and Immunity Compliance

ZOLL ventilators are suitable for use in all establishments. Be prepared to use a manual ventilation technique in the event of ventilator interference or failure.

Warning! Use of this equipment adjacent to or stacked with other equipment should be avoided because it could result in improper operation. If such use is necessary, this equipment and the other equipment should be observed to verify that they are operating normally.

The ventilator has an external sensor/transducer (the Pulse Oximeter sensor) that could affect product compliance.

Warning! Use of accessories, transducers and cables other than those specified or provided by the manufacturer of this equipment could result in increased electromagnetic emissions or decreased electromagnetic immunity of this equipment and result in improper operation.

Warning! Portable RF communications equipment (including peripherals such as antenna cables and external antennas) should be used no closer than 30 cm (12 inches) to any part of a ZOLL ventilator, including cables specified by the manufacturer. Otherwise, degradation of the performance of this equipment could result.

ZOLL ventilators should be observed to verify normal operation. If abnormal performance is observed, additional measures may be necessary, such as re-orienting or relocating the ventilator. Ventilator alarms may be issued in the event the ventilator is affected by electromagnetic disturbance.

Compliance for each emissions and immunity standard or test specified:

| Emissions Test | Compliance | Electromagnetic Environment Guidance |
|--|------------|--|
| ZOLL ventilators are intended for use in the electromagnetic environment specified below. The customer or user of the ventilator should ensure that they are used in such an environment | | |
| RF emissions CISPR 11 | Group 1 | ZOLL ventilators use RF energy only for their internal function. Therefore, their RF emissions are very low and are not likely to cause any interference in nearby electronic equipment. |
| RF emissions CISPR 11 | Class B | ZOLL ventilators are suitable for use in all establishments, |
| Harmonic emissions IEF 61000-3-2 | Class A | |
| Voltage fluctuations/flicker emissions IEC 61000-3-3 | Complies | |

Electromagnetic Immunity

The device is intended for use in the electromagnetic environment as specified below. Operations outside of this environment could result in interference with the display or the ability to provide therapy.

| Immunity Test | Test level | Compliance level | Electromagnetic Environment Guidance |
|--|--|--|--|
| Electrostatic discharge (ESD) IEC 61000-4-2 | ± 8 kV contact ± 15 kV air | ± 8 kV contact ± 15 kV air | The relative humidity should be at least 30%. |
| Electrical fast transient/burst IEC 61000-4-4 | ± 2 kV for power supply lines ± 1 kV for input/output lines | ± 2 kV for power supply lines ± 1 kV for input/output lines | Mains power quality should be that of a typical commercial or hospital environment. |
| Surge IEC 61000-4-5 | ± 1 kV line(s) to line(s) ± 2 kV line(s) to earth | ± 1 kV line(s) to line(s) ± 2 kV line(s) to earth | Mains power quality should be that of a typical commercial or hospital environment. |
| Voltage dips, short interruptions, and voltage variations on power supply input lines IEC 61000-4-11 | 0 % U_T , 0.5 cycles at 0, 45, 90, 135, 180, 225, 270, and 315 degrees; 0 % U_T , 1 cycle and 70 % U_T , 25/30 cycles; single phase at 0 degrees | 0 % U_T , 0.5 cycles at 0, 45, 90, 135, 180, 225, 270, and 315 degrees; 0 % U_T , 1 cycle and 70 % U_T , 25/30 cycles; single phase at 0 degrees | Mains power quality should be that of a typical commercial or hospital environment. If the user of the ventilator requires continued operation during power mains interruptions, it is recommended that the ventilator be powered from an uninterruptible power supply or a battery. |
| Power frequency (50/60) magnetic field IEC 6100-4-8 | 30 A/m | 30 A/m | Power frequency magnetic fields should be at levels characteristic of a typical location at a typical commercial or hospital environment. For ventilators labeled for MR environments, follow the specific directions that ZOLL provides. |
| Conducted RF IEC 61000-4-6 | 3 V, 0.15 MHz - 80 MHz; 10 V in ISM and amateur radio bands between 0.15 MHz and 80 MHz; 80 % AM at 5 Hz | 3 V, 0.15 MHz - 80 MHz; 10 V in ISM and amateur radio bands between 0.15 MHz and 80 MHz; 80 % AM at 5 Hz | |
| Radiated RF IEC 61000-4-3 | 20 V/m, 80 MHz - 2.7 GHz, 80 % AM at 5 Hz | 20 V/m, 80 MHz - 2.7 GHz, 80 % AM at 5 Hz | |
| <p>NOTE 1: U_T is the AC mains voltage prior to application of the test level</p> <p>NOTE 2: ESD discharges and/or high field environments may cause the ventilator to alarm.</p> <ul style="list-style-type: none"> In the event of an Internal Communication Failure (for example, Service Codes: 1471, 1472, 1474, and 1475) remove external power supply and cycle power to reset the ventilator. In the event of fault or failure with pulse oximeter (for example: Service Codes: 2301 and 3301), the alarms self-clear, in event the problem persist follow mitigation instructions. | | | |
| No deviations from this collateral standard or allowances were used. | | | |

Basic Safety and Essential Performance

Instructions for maintaining basic safety and essential performance with regard to electromagnetic disturbances for the expected service life:

- Perform preventive maintenance on the ventilator on an annual basis.
- Follow service procedures as defined in the service manual to ensure EMC performance.
- Be prepared to use a manual ventilation technique if the use location is near (for example., less than 1.5 km from) AM, FM, or TV broadcast antennas.

Appendix B

Accessories

The following accessories are available for use with a ZOLL ventilator. To order any of these items, contact ZOLL or your local distributor.

| Part Description |
|--|
| 3 Liter O ₂ Reservoir Kit |
| AC Power line cord, (US Hospital Grade) |
| AC Power line cord, 6 ft (United States Version) |
| AC/DC Power Supply and Line Cord with NEMA 5-15P termination |
| AC/DC Power Supply, (Class I with IEC - C6 connection) 100-240 VAC, 100 W, 24 V, 4.2 A, (includes line cord with NEMA 5-15P Wall Plug) |
| AC/DC Power Supply (Class I with IEC C14 connection) 100-240 VAC, 120 W, 24 V, 5.0 A, (includes line cord with NEMA 5-15P Wall Plug) |
| AC/DC Power Supply (Class II with IEC C8 connection) 100-240 VAC, 120 W, 24 V, 5.0 A, (includes line cord with NEMA 1-15P Wall Plug) |
| Adapter, Metered Dose Inhaler, Adult |
| Adapter, Metered Dose Inhaler, Adult (Case of 25) |
| Adapter, Metered Dose Inhaler, Pediatric/Infant |
| Adapter, Metered Dose Inhaler, Pediatric/Infant (Case of 25) |
| Battery Pack |
| Breathing Circuit support arm for Rolling Cart (ferrous, not for MRI use) |
| Cable, 18", Pulse Oximeter, Disposable, Finger Sensor, Adult |

| Part Description |
|--|
| Cable, 18", Pulse Oximeter, Disposable, Finger Sensor, Pediatric |
| Cable, 3 ft, Masimo Adult Ear Sensor, LNCS Type DC-1, Adult Sensor to DB9 Male Note: All LNCS Masimo cables are approved for use with the ZOLL ventilators |
| Cable, 3 ft, Masimo SET Oximeter, LNCS Type DC-1, Adult Digit Sensor to DB9 Male, Single Patient Note: All LNCS Masimo cables are approved for use with the ZOLL ventilators |
| Cable, 3 ft, Masimo SET Oximeter, LNCS Type DC-1, Adult Digit Sensor to DB9 Male Note: All LNCS Masimo cables are approved for use with the ZOLL ventilators |
| Cable, 3 ft, Masimo SET Oximeter, LNCS Type DC-1, Pediatric Digit Sensor to DB9 Male, Single Patient Note: All LNCS Masimo cables are approved for use with the ZOLL ventilators |
| Cable, 3 ft, Masimo SET Oximeter, LNCS Type Inf/Inf-3, Infant Sensor to DB9 Male |
| Cable, 3 ft, Pulse Oximeter, Reusable, Finger Sensor, Pediatric |
| Cable, 4 ft, Masimo LNCS Patient Cable Type LNC-4, DB9 Female to Male Note: All LNCS Masimo cables are approved for use with the ZOLL ventilators |
| Cable, 6 ft, BS 546 (UK-SA) Plug Right Angle |
| Cable, 6 ft, Continental Europe CEE 7/7 to IEC-60320-C5 2.5 Amp Connector |
| Carry-all Case with AC Receptacle |
| Carry-all Case with Foam Inserts, without AC Receptacle |
| Case, Transit Carry |
| Case, Transit Carry, with AC Bulkhead & USB Connectors |
| Case, Transit Carry, with AC Bulkhead Connector |
| Case, Transit Carry, with Wheels & Pull-Out Handle |
| Case, Transit Carry, with Wheels & Pull-Out Handle, AC Bulkhead Connector |
| CCLAW (Critical Care Litter Attachment Widget) Mounting Bracket |
| Check Valve Kit |
| Circuit (reusable) |
| Circuit (reusable) (Case of 10) |
| Circuit, 12 ft, Vent, Single Limb, Infant/Pediatric (disposable) |
| Circuit, 12 ft, Vent, Single Limb, Infant/Pediatric (disposable) (Case of 10) |
| Circuit, 12 ft, Vent, Single Limb, Pediatric/Adult (disposable) |
| Circuit, 12 ft, Vent, Single Limb, Pediatric/Adult (disposable) (Case of 10) |
| Circuit, 6 ft, Vent, Single Limb, Infant/Pediatric (disposable) |
| Circuit, 6 ft, Vent, Single Limb, Infant/Pediatric (disposable) (Case of 20) |

| Part Description |
|---|
| Circuit, 6 ft, Vent, Single Limb, Pediatric/Adult (disposable) |
| Circuit, 6 ft, Vent, Single Limb, Pediatric/Adult (disposable) (Case of 15) |
| Cord set, 6 ft, IEC 60320-C5 Plug to Country-Specific Connector (Contact factory for complete part number for each country) |
| DC Power Cable, 12 VDC, Ambulance |
| DC Power Cable, 28 VDC, Military Vehicle |
| Extension Cord 8 ft US Hospital Grade Female Plug to Country-Specific Connector (Contact factory for complete part number for each country) |
| Extension Cord Assembly, AS 3112 (Australian) Plug to US Hospital Grade Plug |
| Filter, Bacterial/Viral (B/V) |
| Filter, Disk, B/V, Emergency Air Intake (replaceable part/service item) |
| Filter, HME/B/V, Heat and Moisture Exchanger |
| Gas Output Cap (Package of 10) |
| Harness, Mask, Universal |
| Harness, Mask, Universal (Case of 10) |
| Heat and Moisture Exchanger/Bacterial and Viral Filter (HMF), Adult, Dead-space \leq 75ml |
| Heat and Moisture Exchanger/Bacterial and Viral Filter (HMF), Adult, Dead-space \leq 75ml (Case of 25) |
| Heat and Moisture Exchanger/Bacterial and Viral Filter (HMF), Infant |
| Heat and Moisture Exchanger/Bacterial and Viral Filter (HMF), Infant (Case of 25) |
| Heat and Moisture Exchanger/Bacterial and Viral Filter (HMF), Pediatric (Case of 25) |
| Heat and Moisture Exchanger/Bacterial and Viral Filter (HMF), Pediatric, Dead-space \leq 25ml |
| High pressure Oxygen Hose, DISS x DISS, oxygen, 6' |
| IV support arm for Rolling Cart (aluminum, MRI safe) |
| Mask, CPAP, #1, Small Infant |
| Mask, CPAP, #2, Infant |
| Mask, CPAP, #2, Infant (Case of 20) |
| Mask, CPAP, #2, Infant (Case of 40) |
| Mask, CPAP, #3, Small Child |
| Mask, CPAP, #3, Small Child (Case of 20) |
| Mask, CPAP, #3, Small Child (Case of 40) |
| Mask, CPAP, #4, Child |
| Mask, CPAP, #4, Child (Case of 20) |

| Part Description |
|--|
| Mask, CPAP, #4, Child with harness |
| Mask, CPAP, #4, Child with Harness (Case of 20) |
| Mask, CPAP, #4, Child with Harness (Case of 50) |
| Mask, CPAP, #5, Adult |
| Mask, CPAP, #5, Adult (Case of 20) |
| Mask, CPAP, #5, Adult with Harness |
| Mask, CPAP, #5, Adult with Harness (Case of 20) |
| Mask, CPAP, #5, Adult with Harness (Case of 50) |
| Mask, CPAP, #6, Large Adult |
| Mask, CPAP, #6, Large Adult (Case of 20) |
| Mask, CPAP, #6, Large Adult with Harness |
| Mask, CPAP, #6, Large Adult with Harness (Case of 20) |
| Mask, CPAP, #6, Large Adult with Harness (Case of 50) |
| MRI conditional Rolling Cart |
| Non-MRI Rolling Cart |
| Padded Carry Case, Tan, for ventilator and accessories |
| Power Supply Holder Kit (fits Class I Power Supply with IEC-C6 connection) |
| Test Lung, plastic/silicone |

Appendix C

Pulse Oximeter Principles

The Masimo SET[®] MS board pulse oximeter is based on these principles.

1. Oxyhemoglobin and deoxyhemoglobin differ in their absorption of red and infrared light (spectrophotometer).
2. The volume of arterial blood in tissue and the light absorbed by the blood changes during the pulse (plethysmography). Therefore, the amount of light absorbed by the varying quantities of arterial blood changes as well.
3. Arterio-venous shunting is highly variable and that fluctuating absorbance by venous blood is a major component of noise during the pulse.

Information about wavelength range can be especially useful to clinicians, see Pulse Oximeter Operation below.

Pulse Oximeter Signaling

Figure C-1 illustrates pulse oximeter signaling.

Note: Figure C-1 is intended for conceptual purposes only.

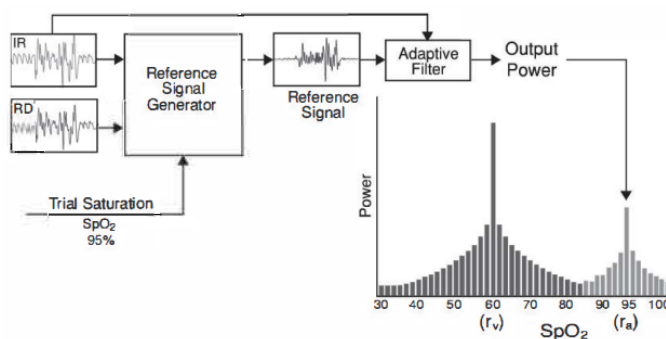

Figure C-1 Example of Pulse Oximeter Signaling

Successful Monitoring for SpO₂, PR and Pi

Stability of the SpO₂ readings may be a good indicator of signal validity. Although stability is a relative term, experience will provide a good feeling for changes that are artifactual or physiological and the speed, timing, and behavior of each.

The stability of the readings over time is affected by the averaging time being used. The longer the averaging time, the more stable the readings tend to become. This is due to a dampened response as the signal is averaged over a longer period of time than during shorter averaging times. However, longer averaging times delay the response of the oximeter and reduce the measured variations of SpO₂ and pulse rate.

Functional Oxygen Saturation (SpO₂)

The pulse oximeter is calibrated to measure and display functional oxygen saturation (SpO₂): the amount of oxyhemoglobin expressed as a percentage of the hemoglobin that is available to transport oxygen.

Note: Dyshemoglobins are not capable of transporting oxygen, but are recognized as oxygenated hemoglobins by conventional pulse oximetry.

Pulse Oximeter Operation

The Masimo SET MS board pulse oximeter as well as traditional pulse oximetry determines SpO₂ by passing red and infrared light into a capillary bed and measuring changes in light absorption during the pulsatile cycle. Red and infrared light-emitting diodes (LEDs) in oximetry sensors serve as the light sources, a photodiode serves as the photodetector. The optical output power of the pulse oximeter is $\leq 15\text{mW}$ radiant power at 50mA pulsed.

Traditional pulse oximetry assumes that all pulsations in the light absorbance are caused by oscillations in the arterial blood volume. This assumes that the blood flow in the region of the sensor passes entirely through the capillary bed rather than through any arterio-venous shunts. The traditional pulse oximeter calculates the ratio of pulsatile absorbance (AC) to the mean absorbance (DC) at each of two wavelengths, 660 nm (red) and 905 nm (infrared):

$$S(660) = AC(660)/DC(660)$$

$$S(905) = AC(905)/DC(905)$$

The oximeter then calculates the ratio of these two arterial pulse-added absorbance signals:

$$R = S(660)/S(905)$$

This value of R is used to find the saturation SpO₂ in a look-up table built into the oximeter's software. The values in the look-up table are based upon human blood studies against a laboratory co-oximeter on healthy adult volunteers in induced hypoxia studies.

The Masimo SET MS board pulse oximeter assumes that arterio-venous shunting is highly variable and that fluctuating absorbance by venous blood is the major component of noise during the pulse. The MS board decomposes S(660) and S(905) into an arterial signal plus a noise component and calculates the ratio of the arterial signals without the noise:

$$S(660) = S1 + N1$$

$$S(905) = S2 + N2$$

$$R = S1/S2$$

Again, R is the ratio of two arterial pulse-added absorbance signals and its value is used to find the saturation SpO₂ in an empirically derived equation into the oximeter's software. The values in the empirically derived equation are based upon human blood studies against a laboratory co-oximeter on healthy adult volunteers in induced hypoxia studies.

The above equations are combined and a noise reference (N') is determined:

$$N' = S(660) - S(905) \times R$$

If there is no noise, $N' = 0$: then $S(660) = S(905) \times R$, which is the same relationship for traditional pulse oximeter.

The equation for the noise reference is based on the value of R , the value being sought to determine the SpO_2 . The MS board software sweeps through possible values of R that correspond to SpO_2 values between 1% and 100% and generates an N' value for each of these R -values. The $S(660)$ and $S(905)$ signals are processed with each possible N' noise reference through an adaptive correlation canceler (ACC), which yields an output power for each possible value of R (i.e., each possible SpO_2 from 1% to 100%). The result is a Discrete Saturation Transform (DST^{TM}) plot of relative output power versus possible SpO_2 value as shown in the following figure where R corresponds to $SpO_2 = 97\%$:

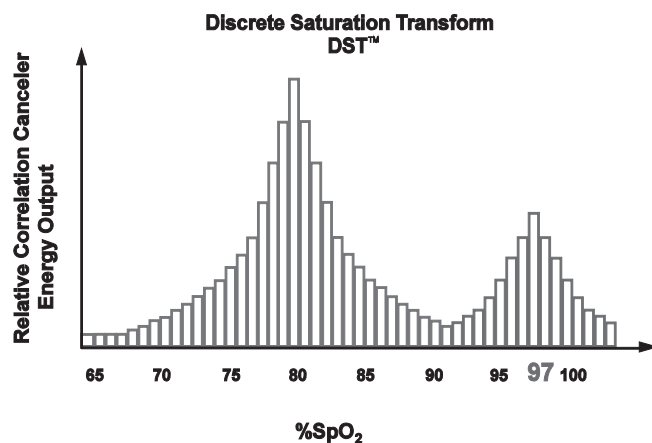

Figure C-2 Pulse Oximeter Discrete Saturation Transformation

The DST plot has two peaks: the peak corresponding to the higher saturation is selected as the SpO_2 value. This entire sequence is repeated once every two seconds on the most recent four seconds of raw data. The MS board SpO_2 therefore corresponds to a running average of arterial hemoglobin that is updated every two seconds.

Sensors are designed as Surface Devices with skin contact for prolonged contact duration, >24hrs to 30days, as defined in ISO 10993-1. All patient contacting materials have passed ISO 10993-1 for cytotoxicity, sensitization, and irritation or intracutaneous reactivity tests.

Sensors are designed not to exceed 41 °C (106 °F) based on a maximum operating temperature of 35 °C (95 °F).

Understanding Alarm Response Delay

As with any pulse oximeter equipment, the audible and visual alarms are subject to alarm response delay, which is composed of Alarm Condition Delay and Alarm Signal Generation Delay. Alarm Condition Delay is the time from the occurrence of the triggering event to when the alarm system determines the alarm condition exists. While Alarm Signal Generation Delay is the time from the onset of an alarm condition to the generation of its alarm signal. Figure C-3 is a simplified illustration of the concept of alarm response delay and does not reflect actual lengths of delays.

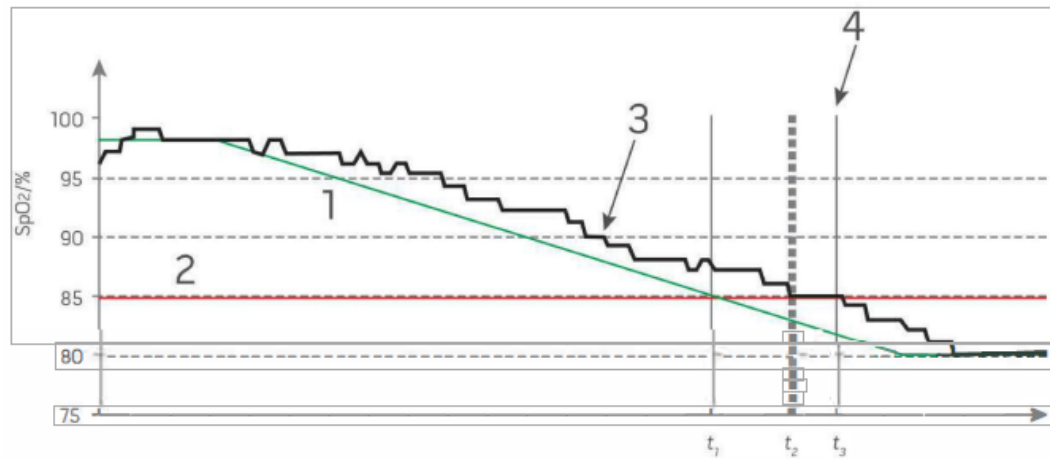

Figure C-3 Alarm Response Delay (Concept)

The Alarm Condition Delay is graphically represented as $t_1 - t_1$ in the figure above to show the delay due to processing and averaging.

The Alarm Signal Generation Delay is graphically represented as $t_3 - t_1$ in the figure above to show the delay due to alarm system strategy and communication time.

The overall alarm system delay time is graphically represented as $t_3 - t_1$.

Appendix D

Troubleshooting Patient Circuits

This appendix provides information on troubleshooting patient circuits.

Troubleshooting Procedure

If there are circuit-related alarms during set up or initial use, such as Disconnect, PEEP Leak, Low Airway Pressure, or Auto-PEEP, check all circuit connections and the exhalation valve.

If the exhalation valve is not performing, manually ventilate the patient and perform the following procedure:

1. Using a hemostat or a tongue blade, carefully open the exhalation valve as we show in Figure D-1. Remove the top cover first, and then remove the silicon diaphragm. Place the silicon diaphragm in a clean area on disposable circuits only. Do not attempt to the following procedure on a reusable circuit.

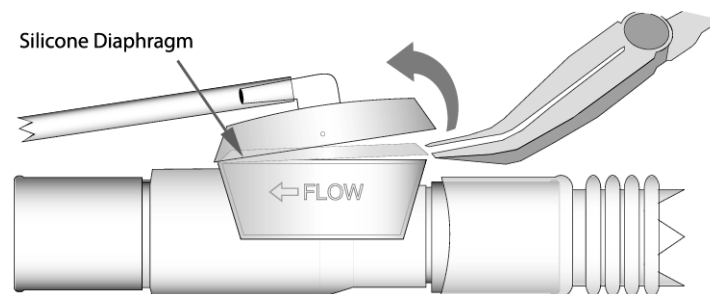

Figure D-1 Removing Silicon Diaphragm -- Pediatric/Adult Patient Circuit

2. Examine the silicon diaphragm for kinks, cuts, holes, or inconsistencies in the material. See Figure D-2.

If the diaphragm is kinked, relax the silicone diaphragm with your fingers, ensuring that there are no longer any kinks (this usually takes a few seconds).

If the diaphragm has a hole or cuts, replace the patient Circuit.

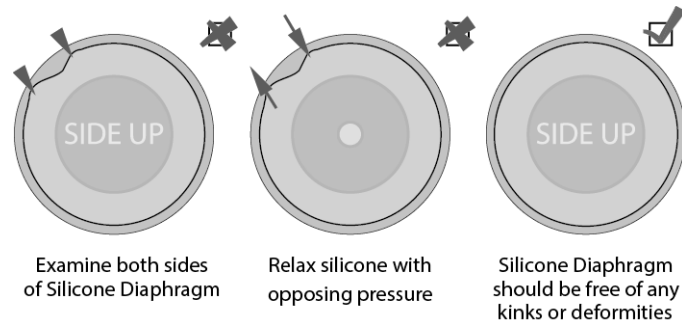

Figure D-2 Examining the Patient Circuit's Silicone Diaphragm

3. Carefully re-seat the silicone diaphragm in the exhalation valve seat. Tap around the silicone diaphragm lightly to ensure that kinks do not develop when closing the exhalation valve. See Figure D-3.
4. Locate the top of the exhalation valve, taking care not to touch the silicone diaphragm. Ensure that the barbed end with tubing is pointing into the FLOW direction. Apply enough pressure to *snap* the exhalation valve cover in place.

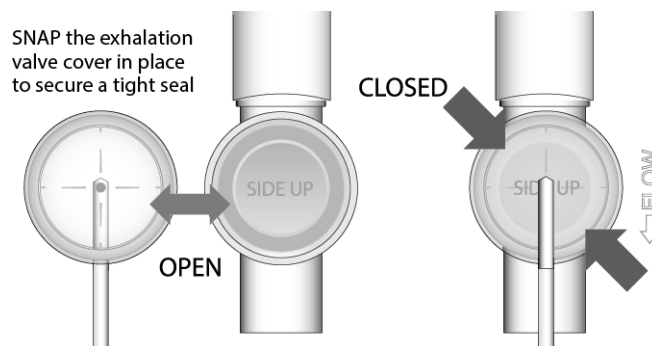

Figure D-3 Closing Exhalation Valve Cover

5. Test the patient circuit with a test lung before using it with a patient. If it fails to perform, replace the patient circuit.

Appendix E

Transitions

This appendix provides information on performing ventilation transitions. Topics include:

- Transition overview
- Transitions for AC and SIMV
- Transitions for CPAP and BL Mode
- Transitions with Spontaneous Breath Modes
 - AC or SIMV to CPAP
 - AC or SIMV to BL
 - CPAP or BL to AC(P) or SIMV(P)

Transition Overview

When an operator changes a mode, the ventilator makes initial adjustments to parameter settings and alarm conditions to ensure safe operation while the operator completes the transition.

Specific types of transitions are described in this appendix. Parametric alarm limits are adjusted (within constraints) or suppressed, depending on the initial settings and the mode change. The Apnea Back Up mode (see Chapter 5) and Leak Compensation selection (See Chapter 4) is an attribute of a transition.

Transition details are described in the sections that follow.

Mode Transition and Leak Compensation Selection

The general approach to maintaining the delivered tidal volume is described for the following parameters.

- BPM
- Vt
- PIP

Note: The breath rate alarm limits are not changed during the transitions described below.

BPM Parameter Window Group

Note the following:

- The rate parameters (BPM, I:E, Ti) remain unchanged.
- The breath rate alarm limits remain unchanged
- The Rise Time table below identifies the rise time assigned for increasing tidal volumes.

Note: The breath rate alarm limits are not changed during the transitions described below.

| Rise Time | Vt High Alarm Limits |
|-----------|----------------------|
| 10 | < 100 |
| 9 | 100-199 |
| 8 | 200-299 |
| 6 | 300-399 |
| 3 | 400-499 |
| 2 | 500-799 |
| 1 | 800+ |

Vt Parameter Window Group

Note the following:

- The Vt parameter reflects the selected target (solid or hollow font), the measured value is used as the transition value.
- The measured Vt is used to determine the Vt High alarm and Vt Low limit brackets.

PIP Parameter Window Group

Note the following:

- The PIP parameter reflects the selected target (solid or hollow font), the measured value is used as the transition value.
- The measured PIP is used to determine the High Airway Pressure Alarm Limit (PIPHL), and the Low Airway Pressure Alarm Limit (PIPLL).
- The secondary parameters (e.g. PEEP, EPAP, PS, IPAP) are updated within the constraints.

AC and SIMV Transitions

This section describes three types of AC and SIMV transitions and discusses constraints.

- Mode
- Control Target
- Leak Compensation

AC and SIMV Mode Transitions

When there are no changes to the control target.

- For the transition to SIMV mode, the breath uses the current setting (AC to SIMV) or the Apnea backup rate (CPAP/BL to SIMV). The spontaneous breath setting is determined by the delivered volume at time of transition, and the rise time setting is determined using the Vt alarm setting (see above).
- The AC breath settings are maintained when transitioning from SIMV to AC modes or the Apnea back rate (CPAP/BL to AC).

When the operator changes between (V) and (P) targets the primary adjustable parameter is changed to solid font, and:

- The measured PIP determines the set PIP (as long as it is greater than (PEEP +5) cm H₂O).
- The settings are bracketed for the airway pressure alarm limits. The high pressure limit adds 5 cm H₂O (as long as it is greater than PS + PEEP + 5).

AC and SIMV Leak Compensation Selection

Leak compensation is available for pressure targeted breaths.

- When the operator Starts LC, the parameter limit alarm settings are disabled
- Tidal Volume Alarms: Upper and Lower limits are determined from Vt at time of transition.
- Low Airway Pressure Alarm: When turning LC OFF, the parameter limit alarm settings are set if the alarm has been suppressed.
 - For CPAP, the setting is the lesser of PIP-5 or (PS+PEEP)-5.

AC and SIMV Transitions and Leak Compensation is summarized below:

| Parameter Changes | Mode Transitions | | | | AC(P) or SIMV(P) | |
|----------------------------------|------------------|------------|------------|------------|------------------|-----------|
| | AC to SIMV | SIMV to AC | (V) to (P) | (P) to (V) | LC ON | LC OFF |
| BPM, I:E (or Itime) | | | | | | |
| Rise Time | | | RT Table | | | |
| Vt | | | | 50, 1500 | | |
| High Vt Upper Alarm Limit | Max: 2000 | | Max: 2000 | Max: 2000 | OFF | Max: 2000 |
| Low Vt Lower Alarm Limit | Max: 500 | | Max: 500 | Max: 500 | OFF | Max: 500 |
| PIP | | | 10, 35 | | | |
| High Airway Pressure Alarm Limit | | | (20, 40) | | | |
| Low Airway Pressure Alarm Limit | | | Minimum: 7 | | OFF | (3,35) |
| PEEP | Minimum: 3 | | | | Minimum: 3 | |

CPAP and BL Transitions

This section describes two types of transitions for CPAP and BL and discusses constraints.

- Mode
- Leak Compensation

CPAP and BL Mode Transition

When the operator changes between CPAP and BL options:

- For these transitions PEEP and EPAP are the same value.
- For transitions from CPAP to BL mode, IPAP is set as PS+PEEP (as long as it is greater than (4 + PEEP) cm H₂O. See below for summary table.

CPAP and BL Leak Compensation Selection

When the ventilator is used for noninvasive support (for example, Mask CPAP), the LC is typically turned on.

When turning LC ON, the alarms are suppressed.

- Tidal Volume Alarms: the upper and lower limits are determined from Vt at time of transition.

- Low Airway Pressure Alarm: when turning LC OFF, the parameter limit alarm settings are set if the alarm has been suppressed.
 - For BL, the setting is the lesser of: PIP-5 or PS - 5
 - For CPAP, the setting is the lesser of PIP-5 or ((PS+PEEP) -5).

A table that describe CPAP and BL Mode Transitions and LC (ON/OFF) is provided below.

| Parameter Change | CPAP to BL | BL to CPAP | LC ON | LC OFF |
|----------------------------------|------------|------------|---------------|-----------|
| BPM, I:E (or Itime) | | | | |
| Rise Time | | | | |
| Vt | | | | |
| High Vt Upper Alarm Limit | | | OFF | Max: 2000 |
| Low Vt Lower Alarm Limit | | | OFF | Max: 500 |
| PIP | | | | |
| High Airway Pressure Alarm limit | | | | |
| Low Airway Pressure Alarm Limit | | | OFF | (3, 35) |
| PEEP | | | Minimum: 3 | |
| PS | | (0, 60) | | |
| IPAP | (6, 60) | | | |

Spontaneous Breath Mode Transitions

This section addresses the following:

- AC or SIMV to CPAP
- AC or SIMV to BL
- CPAP or BL to AC (P) or SIMV (P)

AC or SIMV to CPAP Transitions with Spontaneous Breath

When the operator changes AC or SIMV to CPAP, note the following:

- The rate settings are saved as Apnea Back Up Settings
- The rise time setting:
 - From AC: Uses the RT table
 - From SIMV: No change
- For AC(V) or SIMV(V), the Tidal Volume Alarms: Upper and Lower limits are determined from V_t at time of transition.
- The PIP is saved as the backup PIP; this saved PIP value is dependent on PEEP, where MIN is the lesser of PEEP measured and (set High Limit -1) assigned as noted:
 - For $PEEP < 3$, PIP is set to $(3 - PEEP) - MIN$
 - For $3 < PEEP < 15$, PIP is set to MIN
 - For $PEEP > 15$, PIP is set to $(15 + PEEP) - MIN$
- High Airway Pressure Alarms limits dependent on PEEP,
 - For $3 < PEEP < 15$, there limit remains as set.
 - For constrained PEEP the limit is the greater of (Backup PIP + 5) or (PS + PEEP + 5)
- Low Airway Pressure Alarms limits dependent on PEEP,
 - For $3 < PEEP < 15$, there limit remains as set.
 - For $PEEP < 3$, the limit is the lesser of (Backup PIP - 3, PEEP - 3)
- PEEP reset between 3 and 15.
- For the PS setting:
 - From AC: PS = 0
 - From SIMV: No change

AC or SIMV to BL Transitions with Spontaneous Breath

When the operator changes AC or SIMV to BL, note the following:

- The rate settings are saved as Apnea Back Up Settings
- The rise time setting:
 - From AC: Uses the RT table
 - From SIMV: No change
- For AC(V) or SIMV(V), the Tidal Volume Alarms: Upper and Lower limits are determined from V_t at time of transition.
- The PIP is saved as the backup PIP; this saved PIP value is dependent on PEEP, where MIN is the lesser of PEEP measured and (set High Limit -1) assigned as noted:
 - For $PEEP < 3$, PIP is set to $(3 - PEEP) - MIN$
 - For $3 < PEEP < 15$, PIP is set to MIN
 - For $PEEP > 15$, PIP is set to $(15 + PEEP) - MIN$
- High Airway Pressure Alarms limits dependent on PEEP:
 - For $3 < PEEP < 15$, there limit remains as set.
 - For $PEEP > 15$ the limit is the greater of (Backup PIP + 5) or (IPAP + 5)
- Low Airway Pressure Alarms limits dependent on PEEP:
 - For $3 < PEEP < 15$, there limit remains as set.
 - For $PEEP < 3$, the limit is the lesser of (Backup PIP - 3, IPAP - 3)
- PEEP reset between 3 and 15.
- The IPAP setting is changed for BL selections:
 - From AC (V): $IPAP = 4 + PEEP$
 - From AC (P): $IPAP = 7 + PEEP$
 - From SIMV: (V or P) $IPAP = \text{greater of } (PS + PEEP, 4 + PEEP)$

CPAP or BL to (P) Transitions with Spontaneous Breath

When the operator changes CPAP or BL to (P), note the following:

- The rate settings are saved as Apnea Back Up Settings
- The rise time setting ; No Change
- The PIP is from Apnea Back-up

When the operator changes AC or SIMV to BL:

- The rate settings are saved as Apnea Back Up Settings
- The rise time setting
 - From AC: Uses the RT table
 - From SIMV: No change
- For AC(V) or SIMV(V), the Tidal Volume Alarms: Upper and Lower limits are determined from V_t at time of transition.
- The PIP is saved as the backup PIP; this saved PIP value is dependent on PEEP (where MIN is the lesser of PEEP measured and (set High Limit - 1) assigned as noted:
 - For $PEEP < 3$: PIP is set to $(3 - PEEP) - MIN$
 - For $3 < PEEP < 15$: PIP is set to MIN
 - For $PEEP > 15$: PIP is set to $(15 + PEEP) - MIN$
- High Airway Pressure Alarms limits dependent on PEEP,
 - For $3 < PEEP < 15$: there limit remains as set.
 - For $PEEP > 15$: the limit is the greater of (Backup PIP + 5) or (IPAP + 5)
- Low Airway Pressure Alarms limits dependent on PEEP,
 - For $3 < PEEP < 15$: there limit remains as set.
 - For $PEEP < 3$, the limit is the lesser of (Backup PIP - 3, IPAP - 3)
- PEEP reset between 3 and 15.
- The IPAP setting is changed for BL selections:
 - From AC (V), $IPAP = 4 + PEEP$
 - From AC (P), $IPAP = 7 + PEEP$
 - From SIMV (V or P) $IPAP = \text{greater of } (PS + PEEP, 4 + PEEP)$

CPAP or BL to SIMV (P) Transitions with Spontaneous Breath

Note the following:

- The rate settings are saved as Apnea Back Up settings
- The rise time setting: Not Changed
- The PIP is from Apnea Back-Up
- The PS settings change as follows:
 - To AC from CPAP or BL: $PS=0$
 - To SIMV from CPAP: $PS = 0$
 - To SIMV from BL: $PS = IPAP - EPAP$

A summary of the transitions is provided In the table that follows.

| Parameter Change | (V) to CPAP | (V) to BL | (P) to CPAP | (P) to BL | CPAP to (P) | BL to (P) |
|----------------------------------|--|--|--|--|---|---------------------------------------|
| BPM, I:E (or Itime) | Saved as Back Up | Saved as Back Up | Saved as Back Up | Saved as Apnea Back Up | Saved as Apnea Back Up | Saved as Apnea Back Up |
| Rise Time | From AC: RT Table From SIMV: No Change | From AC: RT Table From SIMV: No Change | | | | |
| Vt | | | | | | |
| High Vt Upper Alarm Limit | Max: 2000 | Max: 2000 | | | | |
| Low Vt Lower Alarm Limit | Max: 500 | Max: 500 | | | | |
| PIP (see above) | Saved as Back Up | Saved as Back Up | Saved as Back Up | Saved as Back Up | Uses Apnea Back Up | Uses Apnea Back Up |
| High Airway Pressure Alarm Limit | No Change for 3 < PEEP < 15 Else (20, 40)* see above | No Change for 3 < EPAP < 15 Else (20,40)* see above | No Change for 3 < EPAP < 15 Else (20,40)* see above | No Change for 3 < PEEP < 15 Else (20, 40)* see above | | |
| Low Airway Pressure Alarm Limit | No Change for 3 < PEEP < 5 Else (3, 35), See conditions | No Change for 3 < PEEP < 15 Else (3, 3 5), See conditions | No Change for 3 < PEEP < 15 Else (3, 3 5), See conditions | No Change for 3 < PEEP < 5 Else (3, 35), See conditions | | |
| PEEP | (3, 15) | (3, 15) | (3, 15) | (3, 15) | | |
| PS | From AC: 0 From SIMV: No Change | | From AC: AC = 0 From SIMV: No Change | | From AC: AC = 0 From SIMV: No Change | From AC: AC = 0 From SIMV: (0, 60) |
| IPAP | | (0, 60) | | (0, 60) | | |

Index

A

- Abbreviations table 1-8
- Accessories B-1 – B-4
- Alarm configuration 4-37
- Alarm History 4-40
- Alarm Overview 5-1 – 5-2
- Alarm Priorities 5-3
- Alarm Summary 5-16 – 5-41
 - High Priority Alarms 5-16
 - Low Priority Alarms 5-31
 - Medium Priority Alarms 5-22
- Alarm Types 5-4 – 5-11
 - Environmental and Use 5-7
 - Patient Safety 5-4
 - Self-Check 5-9
- Assembly Information 1-2
- Attaching a Patient Circuit to the Ventilator 2-16

B

- Backup 5-15
- Backup Mode
 - Apnea Backup Mode 5-15
- Backup Modes 5-15
- Basic Safety and Essential Performance A-7
- Battery
 - Maintenance 7-6
 - Storage 7-7
- BPM Parameters
 - Alarm Thresholds 4-12
 - BPM Parameter Group Reference 4-15
 - Context Menu 4-12
 - Primary Parameter 4-12
 - Secondary Parameters 4-12

C

- Cautions 1-14
- Controls and Indicators 2-4 – 2-6
- Conventions used in guide 1-7

D

- Default Parameter Settings 4-3 – 4-4
- Disabling Alarms 5-14
- Display Screen 2-5

E

- Electromagnetic Immunity A-6
- Emissions and Immunity Compliance A-5
- Environmental and Use Alarms 5-7
- Essential Performance A-7
- External Power Unavailable 6-1

F

- FDA Tracking 1-14
- FIO₂ Parameters
 - Alarm Thresholds 4-21
 - Context Menu 4-21
 - FIO₂ Parameter Group Reference 4-22
 - Primary Parameter 4-21
 - Secondary Parameters 4-21
- Fresh Gas Intake and Attachments 2-7

G

- Guide Updates
 - How to Obtain 1-2
 - Information about 1-2

H

- Harsh Environment Operation
 - Airborne Particulates 6-2
 - Altitude 6-4
 - Extreme Temperature Environments 6-3
 - Rain and Snow 6-4
- Hazardous Environment Filters 6-4 – 6-6
 - Bacterial/Viral 6-5
 - Change/Insertion 7-4 – 7-5
 - Check Valve on Patient Circuit 6-6
 - Chemical/Biological 6-5
 - Fresh Gas/Emergency Air Intake Disk Filter 7-3
 - Replacing 7-4 – 7-5
- Heat and Moisture Exchangers 2-15
- High Pressure Gas Supply 2-12
- High Priority Alarms 5-16
- How to Use this Guide 1-1
- HR Parameters
 - Alarm Thresholds 4-25
 - Context Menu 4-25
 - HR Parameter Group Reference 4-26
 - Primary Parameter 4-25
 - Secondary Parameters 4-25

I

- Indications for Use 1-9

L

- LCD Brightness 4-39
- LCD Contrast 4-38
- Limited Warranty 1-15
- Low Priority Alarms 5-31

M

- Main Features 2-3
- Maintenance
 - Calibration Checks 7-8

General Cleaning 7-2
 Inspecting 7-1
 Post-Contaminated Environment Cleaning 7-2
 Managing Alarms 5-11 – 5-15
 Backup Modes 5-15
 Disabling Alarms 5-14
 Patient Detect Mode 5-14
 Preemptive Muting 5-12
 Start Up Muting 5-12
 Manual Breath 4-27
 Medium Priority Alarms 5-22
 Mode Parameters
 Alarm Thresholds 4-9
 Context Menu 4-10
 Mode Parameter Group Reference 4-11
 Primary Parameter 4-9
 Secondary Parameters 4-9
 MRI Environments 6-7
 MRI Environments, Using the Ventilator 6-7
 Muting Alarms 5-3

N

Notification of Adverse Events 1-15

O

Operation
 Changing Parameter Settings 4-7
 Default Parameter Settings 4-3 – 4-4
 Making Choices from the Start Menu 4-4
 Modes of 3-9
 Saving Changed Parameters 4-8
 Using Last Settings Enabled on Ventilator 4-8

P

Parameter Groups
 BPM Parameters 4-12 – 4-15
 FIO2 Parameters 4-21 – 4-22
 HR Parameters 4-25 – 4-26
 Mode Parameters 4-9 – 4-11
 PIP Parameters 4-18 – 4-20
 SpO2 Parameters 4-22 – 4-24
 Vt Parameters 4-16 – 4-18
 Patient Circuits 2-14 – 2-18
 Attaching Circuit to Ventilator 2-16
 description 2-14
 Intended Use with Ventilator 2-14
 Specifications 2-17
 Troubleshooting D-1 – D-2
 Use with Heat and Moisture Exchangers 2-15
 Patient Detect Mode 5-14
 Patient Safety Alarms 5-4
 Related to Use of a Pulse Oximeter 5-6
 PIP Parameters
 Alarm Thresholds 4-18
 Context Menu 4-19
 PIP Parameter Group Reference 4-20
 Primary Parameter 4-18
 Secondary Parameters 4-18
 Plateau Pressure 4-27
 Plateau Pressure Maneuver 4-27
 Pneumatic Design 2-11
 Pop Up Messages 4-29 – 4-36
 Power Connections 3-7
 Power Sources

Operating Using Battery Power 2-10
 Operating Using External DC Power 2-9
 Powerup 4-37
 Preemptive Muting 5-12
 Pulse Oximeter
 Principles C-1 – C-3
 Pulse Oximeter Compatibility 2-9

S

Setting up the Ventilator 3-1 – 3-12
 Attaching a Patient 3-12
 Attaching an Optional Pulse Oximeter 3-11
 Attaching Optional High Pressure Oxygen Supply 3-3
 Attaching the Patient Circuit 3-2
 Changing Parameter Values 3-10
 Connecting Fresh Gas Intake Attachments 3-4
 Inspecting Fresh Gas Intake Filters 3-4
 Performing an Operational Test 3-10
 Powering ON the ventilator 3-8
 Selecting a Power Source 3-6
 Selecting an Operating Mode (Optional) 3-9
 Selecting Start Menu Option 3-8
 Summary of Steps 3-1
 Software License 1-15
 Specifications A-1 – A-8
 Patient Circuits 2-17
 SpO2 Parameters
 Alarm Thresholds 4-23
 Context Menu 4-23
 Primary Parameter 4-22
 Secondary Parameters 4-23
 SpO2 Parameter Group Reference 4-24
 Start Up Muting 5-12
 Storage 7-7
 Symbols
 in graphical user interface 1-5 – 1-7
 on product 1-2 – 1-4

T

Technical Support 1-16 – 1-17
 Top Panel 2-8
 Transitions 4-36
 Transport Environments, Using the Ventilator 6-2

U

Unit Info 4-40
 Unpacking the Ventilator 1-2
 Using the Main Menu
 Alarm configuration 4-37
 Alarm History 4-40
 LCD brightness 4-39
 LCD Contrast 4-38
 Powerup 4-37
 Unit Info 4-40
 UTC Offset 4-39
 UTC Offset 4-39

V

Ventilator Description 2-3 – 2-12
 Controls and Indicators 2-4
 Display Screen 2-5
 Fresh Gas Intake and Attachments 2-7
 Main Features 2-3
 Pneumatic Design 2-11

- Power Sources 2-9
- Pulse Oximeter Compatibility 2-9
- Top Panel 2-8
- Vt Parameters
 - Alarm Thresholds 4-16
 - Context Menu 4-17
 - Primary Parameter 4-16
 - Secondary Parameters 4-16
 - Vt Parameter Group Reference 4-18

W

- Warnings 1-10 – 1-13
 - Batteries 1-12
 - General 1-10
 - MR Conditional 1-13
 - Patient Safety 1-12
 - Pulse Oximeter 1-11 – 1-12
 - User Safety 1-12
 - Ventilator 1-10 – 1-11

